

プレジャーBT SVI.74

Pleasure Blue Tech SV I.74

プラスチック

単焦点

内面非球面

1.74

仕様

屈折率	1.74
比重	1.47
アッペ数	33
設計	内面非球面

対応コート

- つるつる
- プラチナ
- プラチナBC
- プラチナIRB
- ボードン

製作範囲表

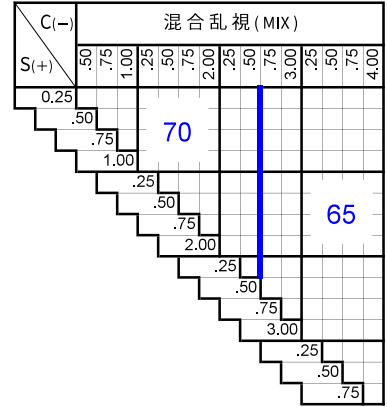
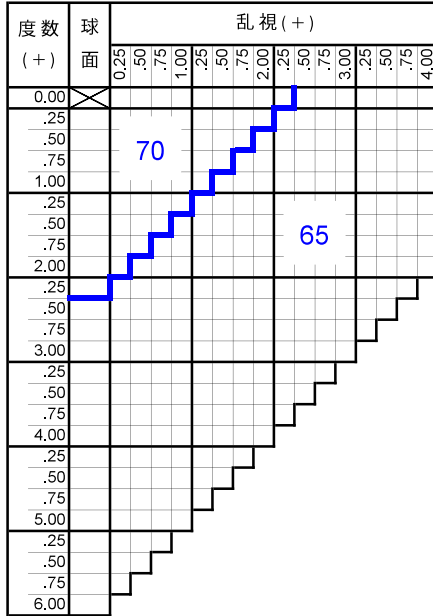
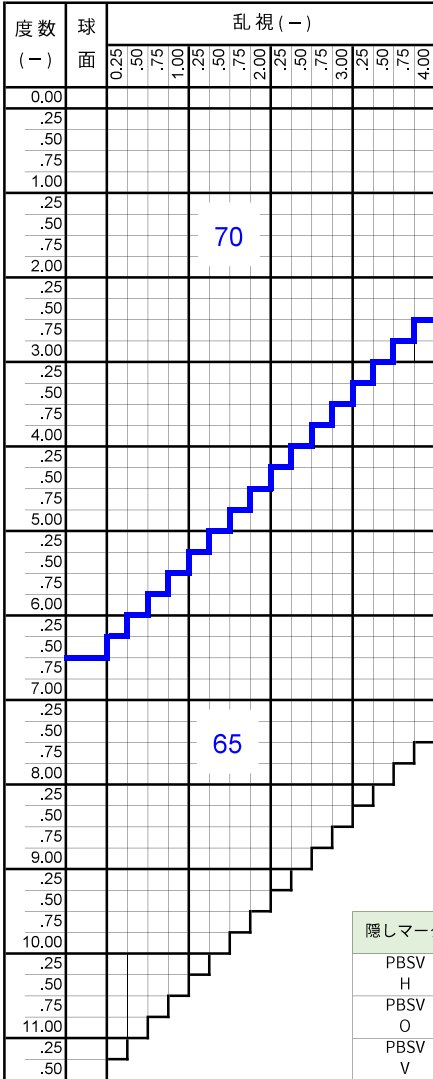

隠しマーク	屈折率
PBSV H	1.60
PBSV O	1.67
PBSV V	1.74

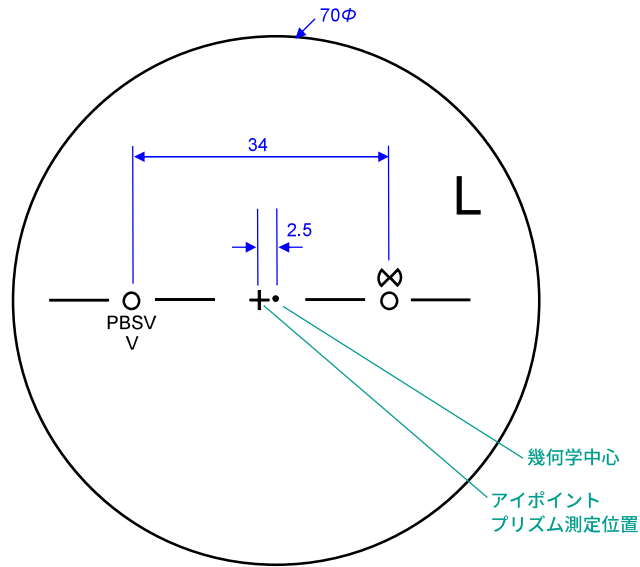

カラー

アリアーテ	○	※1
レイバン G15・G31・#3	×	
見本色	×	
リラックス	×	

特殊加工

外径指定	○	※2
プリズム	○	※3
偏心	×	
カーブ指定	○	※4
UVカット	標準	※5
厚み指定	○	
玉型カット	○	
スライス加工	○	

※1 対象濃度15%以上

※2 [縮小]
(+, MIX範囲) 基準径~最小55mm (1mm単位)
外径は2.5mm内寄せになっています。
・外径70mm → 有効外径75mm
・外径65mm → 有効外径70mm

※3 3△まで可
外径が変化する場合があります

※4 (-) S+C=-4.50まで 5カーブ指定可
(-) S+C=-6.50まで 4カーブ指定可
(-) S+C=-8.00まで 2カーブ指定可
(カーブ指定の時はプリズム不可)

※5 UV420

※注 メガネット発注はトレースデータが必須。
トレースデータがないご注文はオフライン
対応になります。

※注 左右商品違いのペア注文は不可。
左右別々でご注文ください。

原産国

日本

プレジャーBT SVI.67

Pleasure Blue Tech SV I.67

プラスチック

単焦点

内面非球面

1.67

仕様

屈折率	1.67
比重	1.35
アッペ数	32
設計	内面非球面

対応コート

- つるつる
- プラチナ
- プラチナBC
- プラチナIRB
- ボードン
- ミラー (シルバー・ゴールド・ブルー・レッド)

製作範囲表

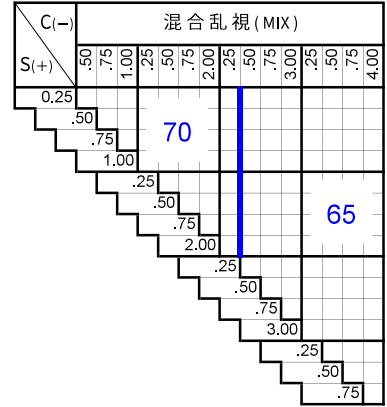
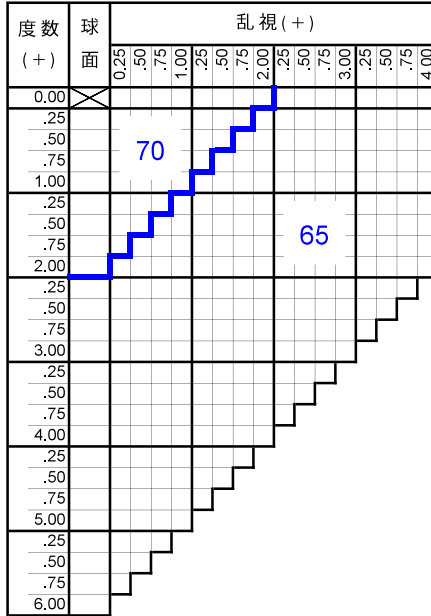
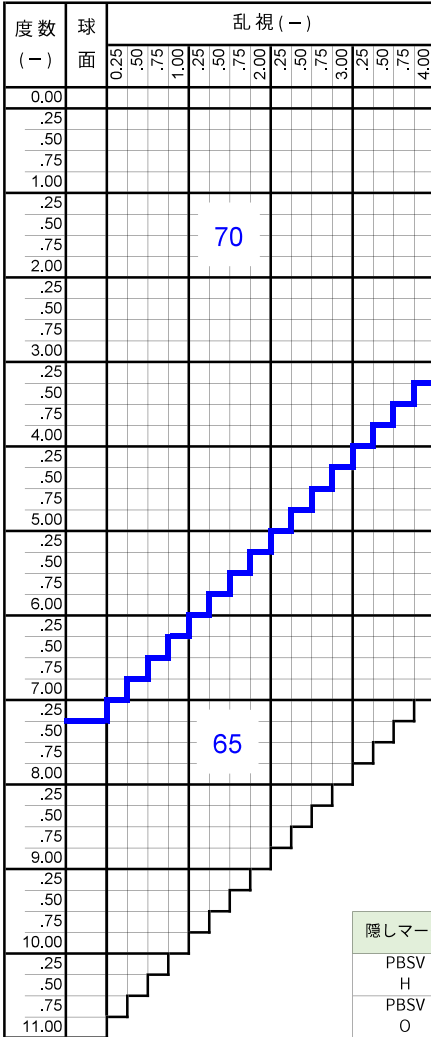

隠しマーク	屈折率
PBSV H	1.60
PBSV O	1.67
PBSV V	1.74

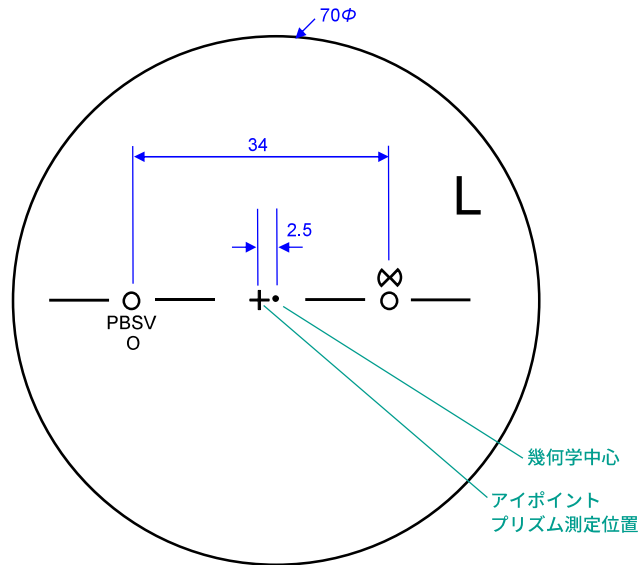

カラー

アリアーテ	○	※1
レイバン G15・G31・#3	×	
見本色	×	
リラックス	×	

原産国

日本

特殊加工

外径指定	○	※2
プリズム	○	※3
偏心	×	
カーブ指定	○	※4
UVカット	標準	※5
厚み指定	○	
玉型カット	○	
スライス加工	○	

※1 対象濃度15%以上

※2 [縮小]

(+, MIX範囲) 基準径~最小55mm (1mm単位)
外径は2.5mm内寄せになっています。

- ・外径70mm → 有効外径75mm
- ・外径65mm → 有効外径70mm

※3 3△まで可

外径が変化する場合があります

※4 (-)S+C=-3.00まで 6カーブ指定可

(-)S+C=-5.00まで 5カーブ指定可

(-)S+C=-6.50まで 4カーブ指定可

(カーブ指定の時はプリズム不可)

※5 UV420

※注 メガネット発注はトレースデータが必須。

トレースデータがないご注文はオフライン対応になります。

※注 左右商品違いのペア注文は不可。

左右別々でご注文ください。

プレジャーBT SVI.60

Pleasure Blue Tech SV I.60

プラスチック

単焦点

内面非球面

1.60

仕様

屈折率	1.60
比重	1.30
アッペ数	42
設計	内面非球面

対応コート

- つるつる
- プラチナ
- プラチナBC
- プラチナIRB
- ボードン
- ビューティフル
- ミラー (シルバー・ゴールド・ブルー・レッド)

製作範囲表

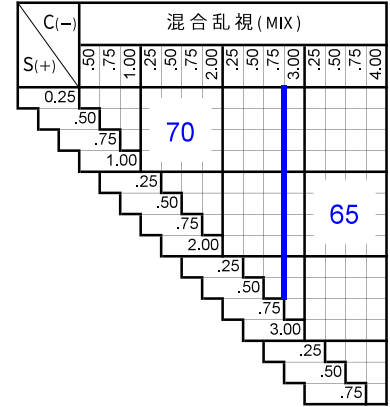
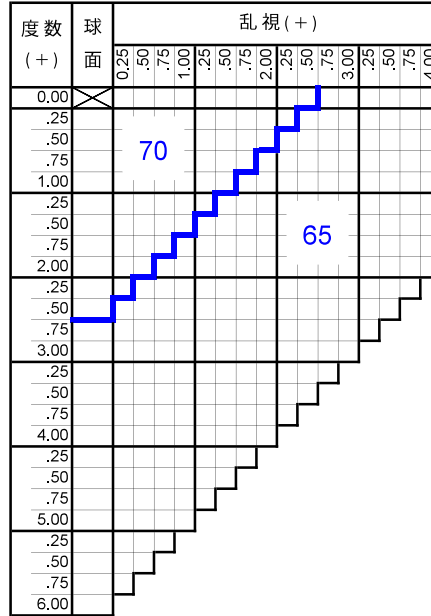
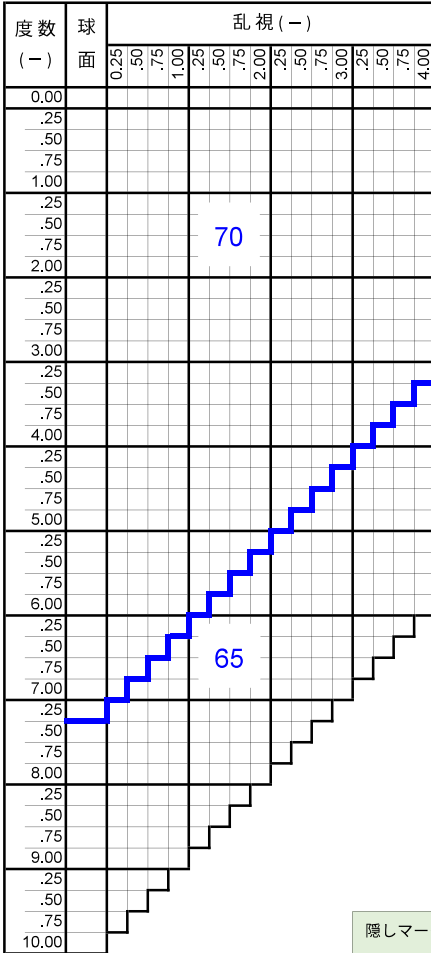

隠しマーク	屈折率
PBSV H	1.60
PBSV O	1.67
PBSV V	1.74

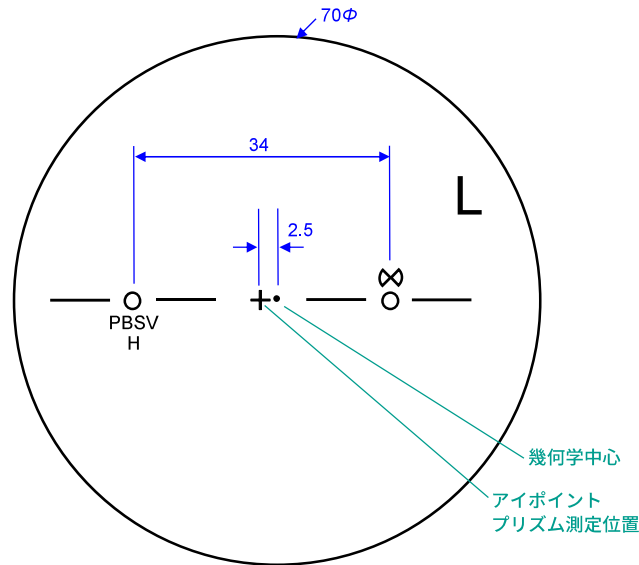

カラー

アリアーテ	○	※1
レイバン G15・G31・#3	×	
見本色	×	
リラックス	×	

原産国

日本

特殊加工

外径指定	○	※2
プリズム	○	※3
偏心	×	
カーブ指定	○	※4
UVカット	標準	※5
厚み指定	○	
玉型カット	○	
スライス加工	○	

※1 対象濃度15%以上

※2 [縮小]
(+, MIX範囲) 基準径~最小55mm (1mm単位)
外径は2.5mm内寄せになっています。
・外径70mm → 有効外径75mm
・外径65mm → 有効外径70mm

※3 3△まで可
外径が変化する場合があります

※4 (-)S+C=-3.00まで 6カーブ指定可
(-)S+C=-5.00まで 5カーブ指定可
(-)S+C=-6.50まで 4カーブ指定可
(カーブ指定の時はプリズム不可)

※5 UV420

※注 メガネツ発注はトレースデータが必須。
トレースデータがないご注文はオフライン
対応になります。

※注 左右商品違いのペア注文は不可。
左右別々でご注文ください。

プレジャーSVI.74

Pleasure SV I.74

プラスチック

単焦点

内面非球面

1.74

仕様

屈折率	1.74
比重	1.47
アッペ数	33
設計	内面非球面

対応コート

- つるつる
- プラチナ
- プラチナBC
- プラチナIRB
- ボードン

製作範囲表

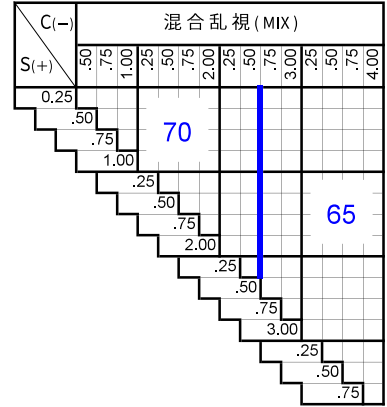
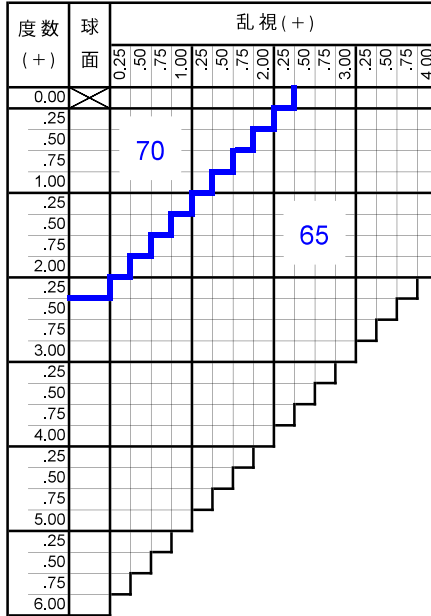
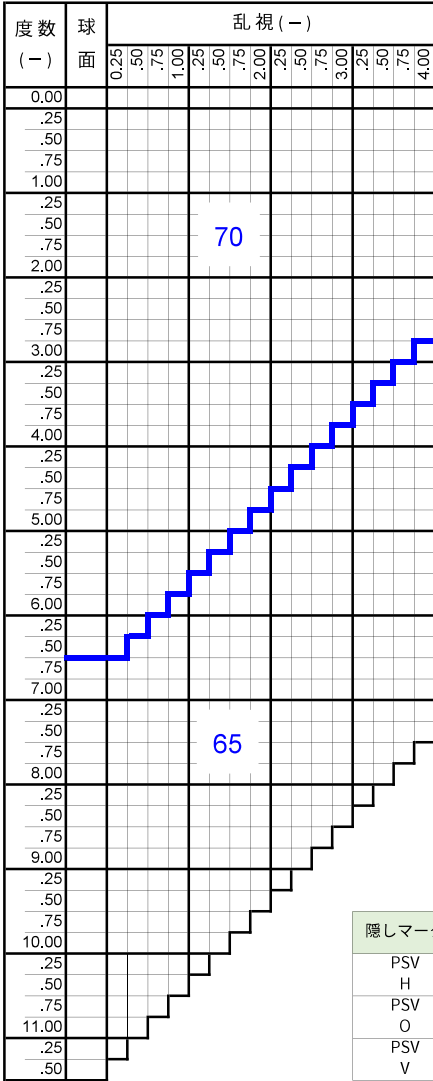

隠しマーク	屈折率
PSV H	1.60
PSV O	1.67
PSV V	1.74

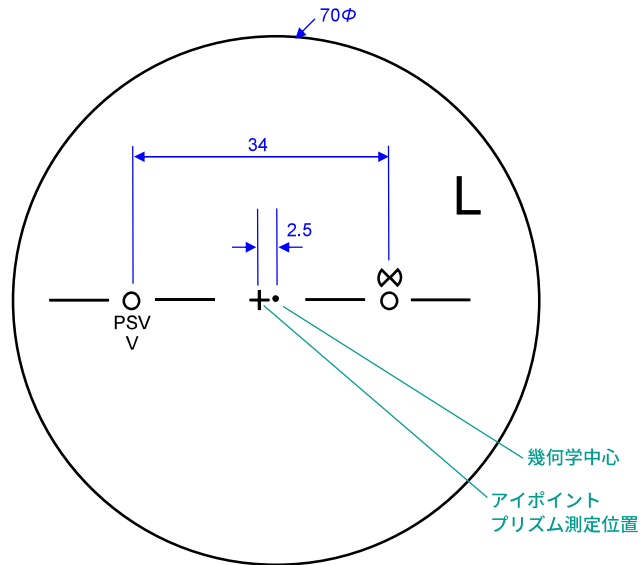

カラー

アリアーテ	○
レイバン G15・G31・#3	○
見本色	○
リラックス	×

原産国

日本

特殊加工

外径指定	○	※1
プリズム	○	※2
偏心	×	
カーブ指定	○	※3
UVカット	標準	※4
厚み指定	○	
玉型カット	○	
スライス加工	○	

※1 [縮小]
(+, MIX範囲) 基準径~最小55mm (1mm単位)
外径は2.5mm内寄せになっています。
・外径70mm → 有効外径75mm
・外径65mm → 有効外径70mm

※2 3△まで可
外径が変化する場合があります

※3 (-) S+C=-4.50まで 5カーブ指定可
(-) S+C=-6.50まで 4カーブ指定可
(-) S+C=-8.00まで 2カーブ指定可
(カーブ指定の時はプリズム不可)

※4 UV400

※注 メガネット発注はトレースデータが必須。
トレースデータがないご注文はオフライン
対応になります。

※注 左右商品違いのペア注文は不可。
左右別々でご注文ください。

プレジャーSVI.67

Pleasure SV I.67

プラスチック

単焦点

内面非球面

1.67

仕様

屈折率	1.67
比重	1.35
アッペ数	32
設計	内面非球面

対応コート

- つるつる
- プラチナ
- プラチナBC
- プラチナIRB
- ミラー (シルバー・ゴールド・ブルー・レッド)

製作範囲表

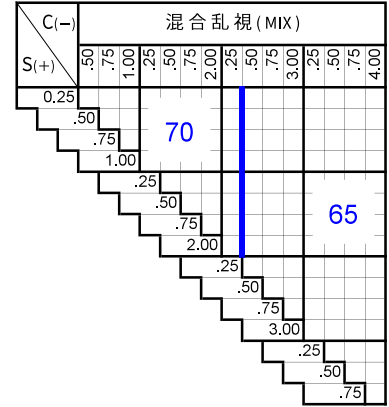
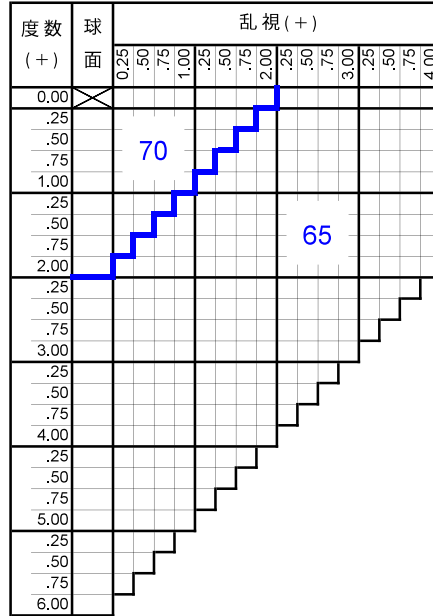
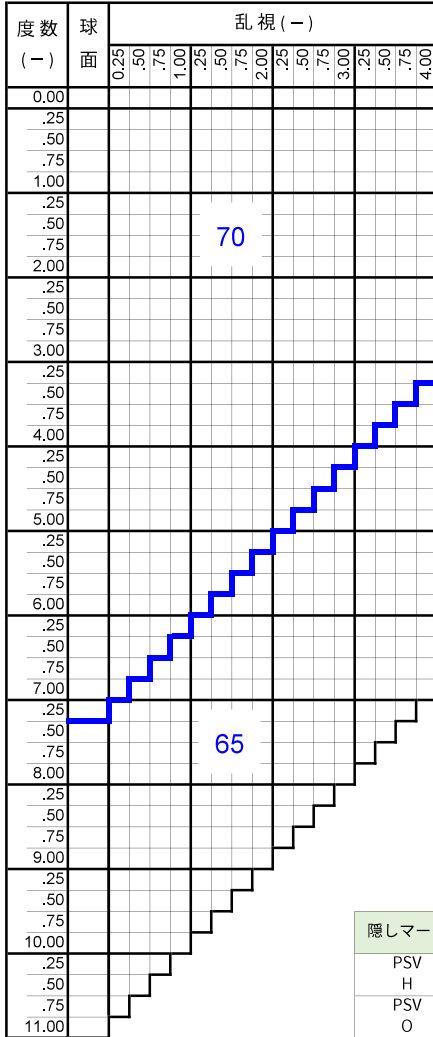

隠しマーク	屈折率
PSV H	1.60
PSV O	1.67
PSV V	1.74

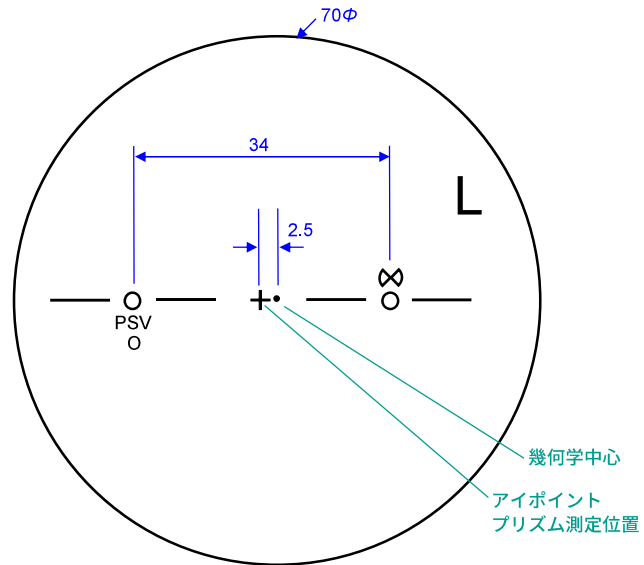

カラー

アリアーテ	○
レイバン G15・G31・#3	○
見本色	○
リラックス	×

特殊加工

外径指定	○	※1
プリズム	○	※2
偏心	×	
カーブ指定	○	※3
UVカット	標準	※4
厚み指定	○	
玉型カット	○	
スライス加工	○	

※1 [縮小]
(+, MIX範囲) 基準径~最小55mm (1mm単位)
外径は2.5mm内寄せになっています。
・外径70mm → 有効外径75mm
・外径65mm → 有効外径70mm

※2 3△まで可
外径が変化する場合があります

※3 (-) S+C=-3.00まで 6カーブ指定可
(-) S+C=-5.00まで 5カーブ指定可
(-) S+C=-6.50まで 4カーブ指定可
(カーブ指定の時はプリズム不可)

※4 UV400

※注 メガネツ発注はトレースデータが必須。
トレースデータがないご注文はオフライン
対応になります。

※注 左右商品違いのペア注文は不可。
左右別々でご注文ください。

原産国

日本

プレジャーSVI.60

Pleasure SV I.60

プラスチック

単焦点

内面非球面

1.60

仕様

屈折率	1.60
比重	1.30
アッペ数	42
設計	内面非球面

対応コート

- つるつる
- プラチナ
- プラチナBC
- プラチナIRB
- ボードン
- ビューティフル
- ミラー (シルバー・ゴールド・ブルー・レッド)

製作範囲表

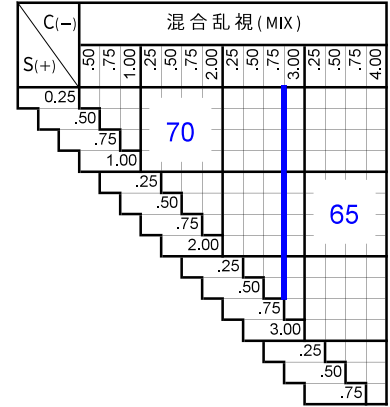
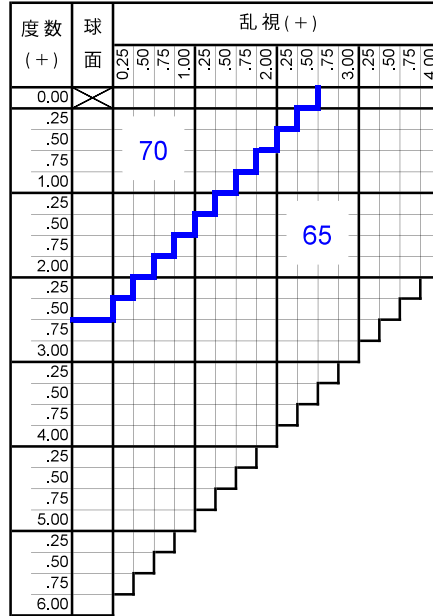
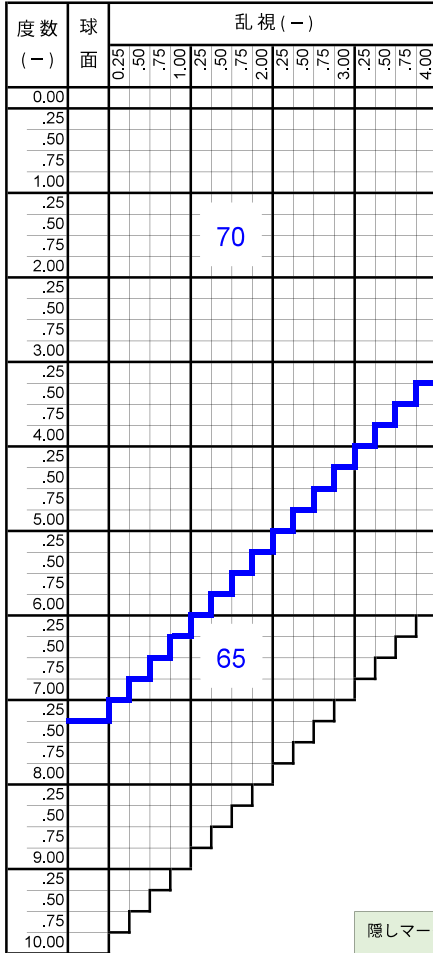

隠しマーク	屈折率
PSV H	1.60
PSV O	1.67
PSV V	1.74

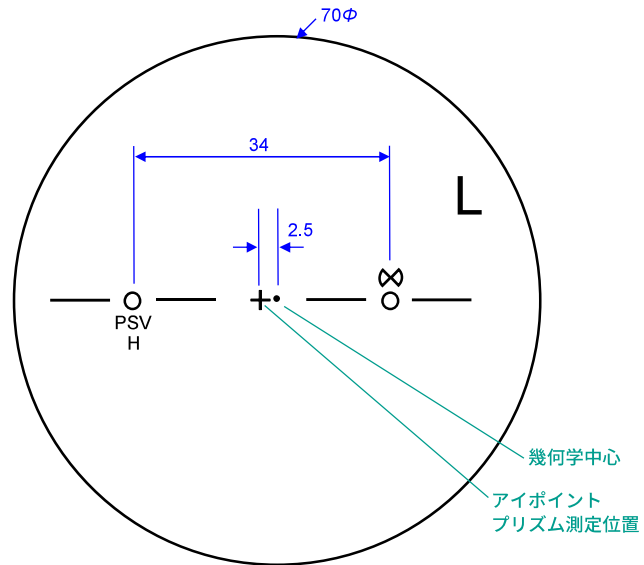

カラー

アリアーテ	○
レイバン G15・G31・#3	○
見本色	○
リラックス	×

特殊加工

外径指定	○	※1
プリズム	○	※2
偏心	×	
カーブ指定	○	※3
UVカット	標準	※4
厚み指定	○	
玉型カット	○	
スライス加工	○	

※1 [縮小]
(+, MIX範囲) 基準径~最小55mm (1mm単位)
外径は2.5mm内寄せになっています。
・外径70mm → 有効外径75mm
・外径65mm → 有効外径70mm

※2 3△まで可
外径が変化する場合があります

※3 (-) S+C=-3.00まで 6カーブ指定可
(-) S+C=-5.00まで 5カーブ指定可
(-) S+C=-6.50まで 4カーブ指定可
(カーブ指定の時はプリズム不可)

※4 UV400

※注 メガネット発注はトレースデータが必須。
トレースデータがないご注文はオフライン
対応になります。

※注 左右商品違いのペア注文は不可。
左右別々でご注文ください。

原産国

日本

T-SV TOTAL HGI. 74AS

T-SV TOTAL HGI. 74AS

プラスチック

単焦点

非球面

1.74

仕様

屈折率	1.74
比重	1.47
アッペ数	33
設計	非球面

対応コート

●プラチナIRB

製作範囲表

度数 (-)	球面	乱視 (-)															
		0.25	.50	.75	1.00	.25	.50	.75	2.00	.25	.50	.75	3.00	.25	.50	.75	4.00
0.00																	
.25																	
.50																	
.75																	
1.00																	
.25																	
.50																	
.75																	
2.00																	
.25																	
.50																	
.75																	
3.00																	
.25																	
.50																	
.75																	
4.00																	
.25																	
.50																	
.75																	
5.00																	
.25																	
.50																	
.75																	
6.00																	
.25																	
.50																	
.75																	
7.00																	
.25																	
.50																	
.75																	
8.00																	
.25																	
.50																	
.75																	
9.00																	
.25																	
.50																	
.75																	
10.00																	
.25																	
.50																	
.75																	
11.00																	
.25																	
.50																	
.75																	
12.00																	
.25																	
.50																	
.75																	
13.00																	
.25																	
.50																	
.75																	
14.00																	
.25																	
.50																	
.75																	
15.00																	
.25																	
.50																	
.75																	
16.00																	
.25																	
.50																	
.75																	
17.00																	
.25																	
.50																	
.75																	
18.00																	

75

70

65

カラー

アリアーテ	○	
レイバン G15・G31・#3	×	
見本色	×	
リラックス	×	

原産国

日本

特殊加工

外径指定	×	
プリズム	○	※1
偏心	×	
カーブ指定	×	
UVカット	標準	※2
厚み指定	×	
玉型カット	○	
スライス加工	×	

※1 3△まで可

※2 UV420

T-SV TOTAL HGI. 67AS

T-SV TOTAL HGI. 67AS

プラスチック

単焦点

非球面

1.67

仕様

屈折率	1.67
比重	1.35
アッペ数	32
設計	非球面

対応コート

●プラチナIRB

製作範囲表

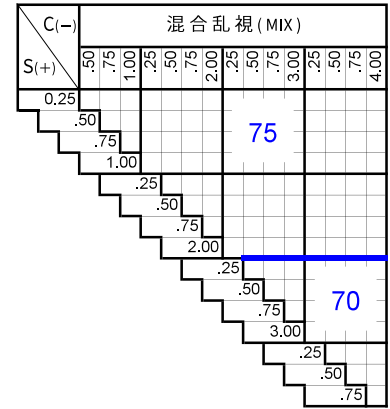
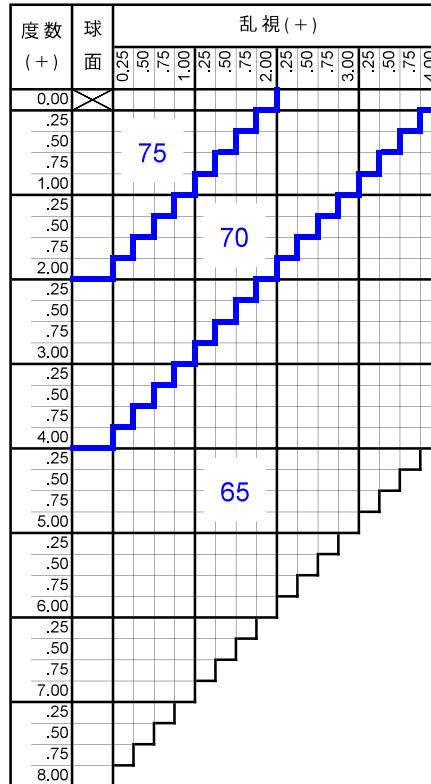
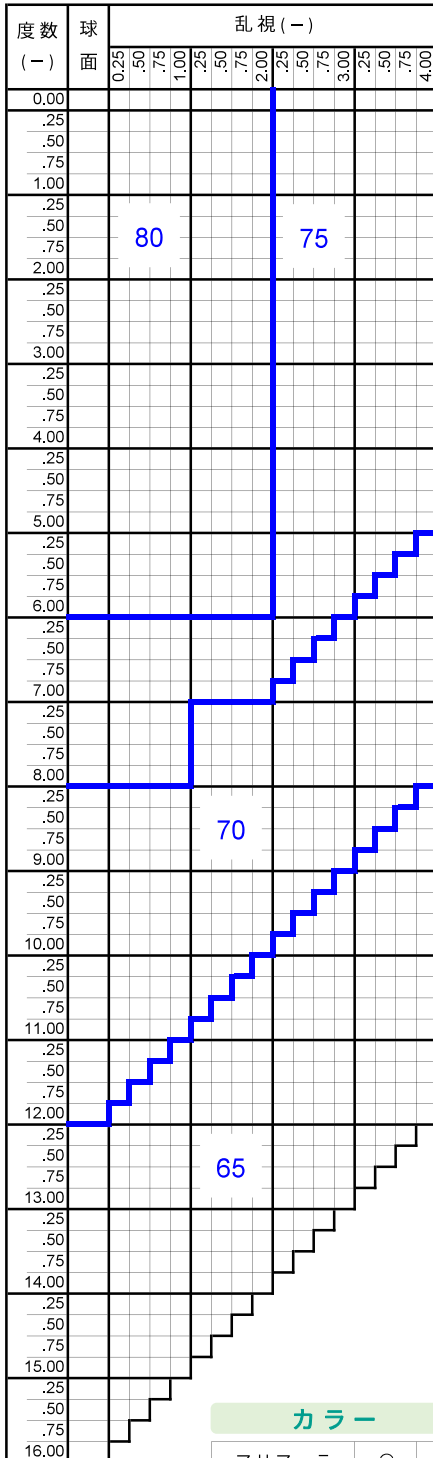

カラー

アリアーテ	○
レイバン G15・G31・#3	○
見本色	○
リラックス	×

特殊加工

外径指定	○	※1
プリズム	○	※2
偏心	×	
カーブ指定	×	
UVカット	標準	※3
厚み指定	○	
玉型カット	○	
スライス加工	○	

※1 [縮小]
(+, MIX範囲) 基準径~最小55mm (1mm単位)

※2 5△まで可

※3 UV420

原産国

日本

T-SV TOTAL HG I.60AS

T-SV TOTAL HG I.60AS

プラスチック

単焦点

非球面

1.60

仕様

屈折率	1.60
比重	1.31
アッペ数	42
設計	非球面

対応コート

●プラチナIRB

製作範囲表

度数 (-)	球面	乱視 (-)															
		0.25	.50	.75	1.00	.25	.50	.75	2.00	.25	.50	.75	3.00	.25	.50	.75	4.00
0.00																	
.25																	
.50																	
.75																	
1.00																	
.25																	
.50																	
.75																	
2.00																	
.25																	
.50																	
.75																	
3.00																	
.25																	
.50																	
.75																	
4.00																	
.25																	
.50																	
.75																	
5.00																	
.25																	
.50																	
.75																	
6.00																	
.25																	
.50																	
.75																	
7.00																	
.25																	
.50																	
.75																	
8.00																	
.25																	
.50																	
.75																	
9.00																	
.25																	
.50																	
.75																	
10.00																	

度数 (+)	球面	乱視 (+)															
		0.25	.50	.75	1.00	.25	.50	.75	2.00	.25	.50	.75	3.00	.25	.50	.75	4.00
0.00																	
.25																	
.50																	
.75																	
1.00																	
.25																	
.50																	
.75																	
2.00																	
.25																	
.50																	
.75																	
3.00																	
.25																	
.50																	
.75																	
4.00																	
.25																	
.50																	
.75																	
5.00																	
.25																	
.50																	
.75																	
6.00																	

C(-) S(+)	混合乱視 (MIX)																
	.50	.75	1.00	.25	.50	.75	2.00	.25	.50	.75	3.00	.25	.50	.75	4.00		
0.25																	
.50																	
.75																	
1.00																	
.25																	
.50																	
.75																	
2.00																	
.25																	
.50																	
.75																	
3.00																	
.25																	
.50																	
.75																	
4.00																	
.25																	
.50																	
.75																	
5.00																	
.25																	
.50																	
.75																	
6.00																	

カラー

アリアーテ	○	
レイバン G15・G31・#3	○	
見本色	○	
リラックス	×	

特殊加工

外径指定	○	※1
プリズム	○	※2
偏心	×	
カーブ指定	×	
UVカット	標準	※3
厚み指定	○	
玉型カット	○	
スライス加工	○	

※1 [縮小]
(+、MIX範囲) 基準径~最小55mm (1mm単位)

※2 3△まで可

※3 UV420

原産国

日本

T-SV SPF HGI.74AS

T-SV SPF HGI.74AS

プラスチック

単焦点

非球面

1.74

仕様

屈折率	1.74
比重	1.47
アッペ数	33
設計	非球面

対応コート

●プラチナIRB

製作範囲表

度数 (-)	球面	乱視 (-)															
		0.25	.50	.75	1.00	.25	.50	.75	2.00	.25	.50	.75	3.00	.25	.50	.75	4.00
0.00																	
.25																	
.50																	
.75																	
1.00																	
.25																	
.50																	
.75																	
2.00																	
.25																	
.50																	
.75																	
3.00																	
.25																	
.50																	
.75																	
4.00																	
.25																	
.50																	
.75																	
5.00																	
.25																	
.50																	
.75																	
6.00																	
.25																	
.50																	
.75																	
7.00																	
.25																	
.50																	
.75																	
8.00																	
.25																	
.50																	
.75																	
9.00																	
.25																	
.50																	
.75																	
10.00																	
.25																	
.50																	
.75																	
11.00																	
.25																	
.50																	
.75																	
12.00																	
.25																	
.50																	
.75																	
13.00																	
.25																	
.50																	
.75																	
14.00																	
.25																	
.50																	
.75																	
15.00																	
.25																	
.50																	
.75																	
16.00																	
.25																	
.50																	
.75																	
17.00																	
.25																	
.50																	
.75																	
18.00																	

75

70

65

カラー

アリアーテ	○	
レイバン G15・G31・#3	×	
見本色	×	
リラックス	×	

原産国

日本

特殊加工

外径指定	×	
プリズム	○	※1
偏心	×	
カーブ指定	×	
UVカット	標準	※2
厚み指定	×	
玉型カット	○	
スライス加工	×	

※1 3△まで可

※2 UV400

T-SV SPF HGI.67AS

T-SV SPF HGI.67AS

プラスチック

単焦点

非球面

1.67

仕様

屈折率	1.67
比重	1.35
アッペ数	32
設計	非球面

対応コート

●プラチナIRB

製作範囲表

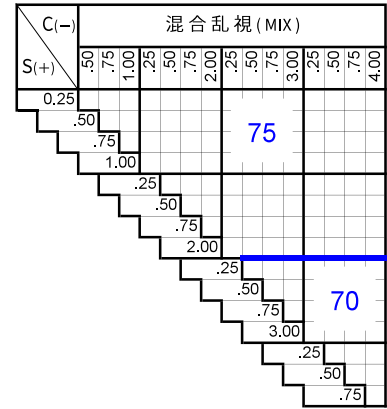
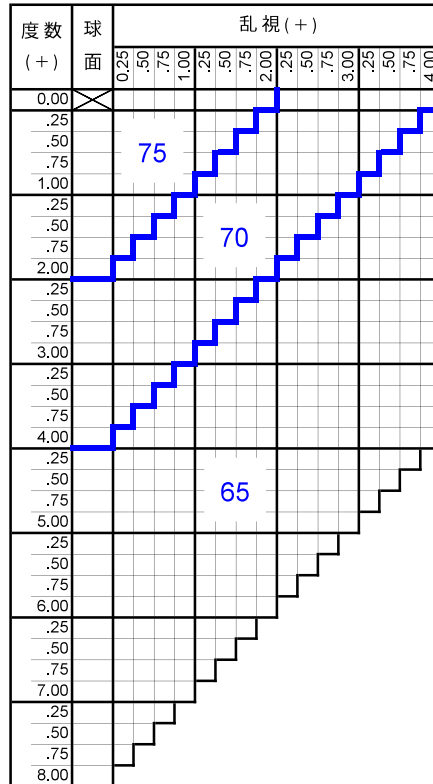
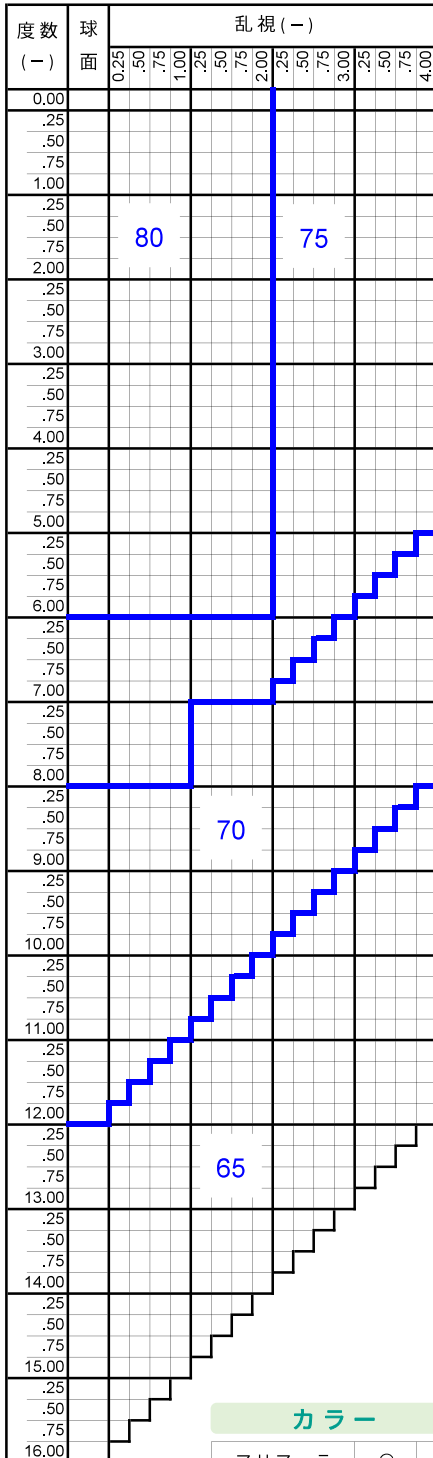

カラー

アリアーテ	○
レイバン G15・G31・#3	○
見本色	○
リラックス	×

特殊加工

外径指定	○	※1
プリズム	○	※2
偏心	×	
カーブ指定	×	
UVカット	標準	※3
厚み指定	○	
玉型カット	○	
スライス加工	○	

※1 [縮小]
(+, MIX範囲) 基準径~最小55mm (1mm単位)

※2 5△まで可

※3 UV400

原産国

日本

T-SV SPF HGI.60AS

T-SV SPF HGI.60AS

プラスチック

単焦点

非球面

1.60

仕様

屈折率	1.60
比重	1.31
アッペ数	42
設計	非球面

対応コート

●プラチナIRB

製作範囲表

度数 (-)	球面	乱視 (-)															
		0.25	.50	.75	1.00	.25	.50	.75	2.00	.25	.50	.75	3.00	.25	.50	.75	4.00
0.00																	
.25																	
.50																	
.75																	
1.00																	
.25																	
.50																	
.75																	
2.00																	
.25																	
.50																	
.75																	
3.00																	
.25																	
.50																	
.75																	
4.00																	
.25																	
.50																	
.75																	
5.00																	
.25																	
.50																	
.75																	
6.00																	
.25																	
.50																	
.75																	
7.00																	
.25																	
.50																	
.75																	
8.00																	
.25																	
.50																	
.75																	
9.00																	
.25																	
.50																	
.75																	
10.00																	

度数 (+)	球面	乱視 (+)															
		0.25	.50	.75	1.00	.25	.50	.75	2.00	.25	.50	.75	3.00	.25	.50	.75	4.00
0.00																	
.25																	
.50																	
.75																	
1.00																	
.25																	
.50																	
.75																	
2.00																	
.25																	
.50																	
.75																	
3.00																	
.25																	
.50																	
.75																	
4.00																	
.25																	
.50																	
.75																	
5.00																	
.25																	
.50																	
.75																	
6.00																	

C(-)	S(+)	混合乱視 (MIX)															
		.50	.75	1.00	.25	.50	.75	2.00	.25	.50	.75	3.00	.25	.50	.75	4.00	
0.25																	
.50																	
.75																	
1.00																	
.25																	
.50																	
.75																	
2.00																	
.25																	
.50																	
.75																	
3.00																	
.25																	
.50																	
.75																	
4.00																	
.25																	
.50																	
.75																	
5.00																	
.25																	
.50																	
.75																	
6.00																	

カラー

アリアーテ	○	
レイバン G15・G31・#3	○	
見本色	○	
リラックス	×	

特殊加工

外径指定	○	※1
プリズム	○	※2
偏心	×	
カーブ指定	×	
UVカット	標準	※3
厚み指定	○	
玉型カット	○	
スライス加工	○	

※1 [縮小]
(+、MIX範囲) 基準径~最小55mm (1mm単位)

※2 3△まで可

※3 UV400

原産国

日本

仕様

屈折率	1.74
比重	1.47
アッペ数	33
設計	非球面

対応コート

- つるつる
- プラチナ
- プラチナBC

製作範囲表

在庫範囲 (つるつる)

度数 (-)	球 面	乱視 (-)							
		0.25	.50	.75	1.00	.25	.50	.75	1.00
0.00									
.25									
.50									
.75									
1.00									
.25									
.50									
.75									
2.00									
.25									
.50									
.75									
3.00									
.25									
.50									
.75									
4.00									
.25									
.50									
.75									
5.00									
.25									
.50									
.75									
6.00									
.25									
.50									
.75									
7.00									
.25									
.50									
.75									
8.00									
.25									
.50									
.75									
9.00									
.25									
.50									
.75									
10.00									
.25									
.50									
.75									
11.00									
.25									
.50									
.75									
12.00									
.25									
.50									
.75									
13.00									
.25									
.50									
.75									
14.00									
.25									
.50									
.75									
15.00									

カラー

アリアーテ	○
レイバン G15・G31・#3	×
見本色	×
リラックス	×

特殊加工

外径指定	×
プリズム	○ ※1
偏心	×
カーブ指定	×
UVカット	標準 ※2
厚み指定	×
玉型カット	○
スライス加工	×

※1 3△まで可

※2 UV400

原産国

日本

スーパーピコットAS

Super Picot AS

プラスチック

単焦点

非球面

1.67

仕様

屈折率	1.67
比重	1.35
アッペ数	32
設計	非球面

対応コート

- つるつる
- プラチナ
- プラチナBC
- ブルークリア
- 内面マルチ (表) ハード (裏) ハードマルチ+つるつる

製作範囲表

+ 在庫範囲 (つるつる)
 ■ 在庫範囲 (プラチナ)

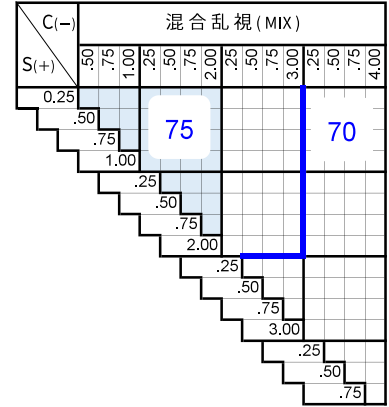
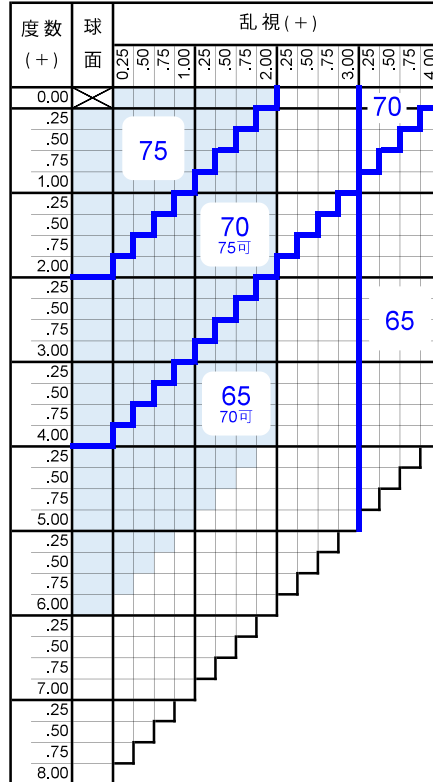
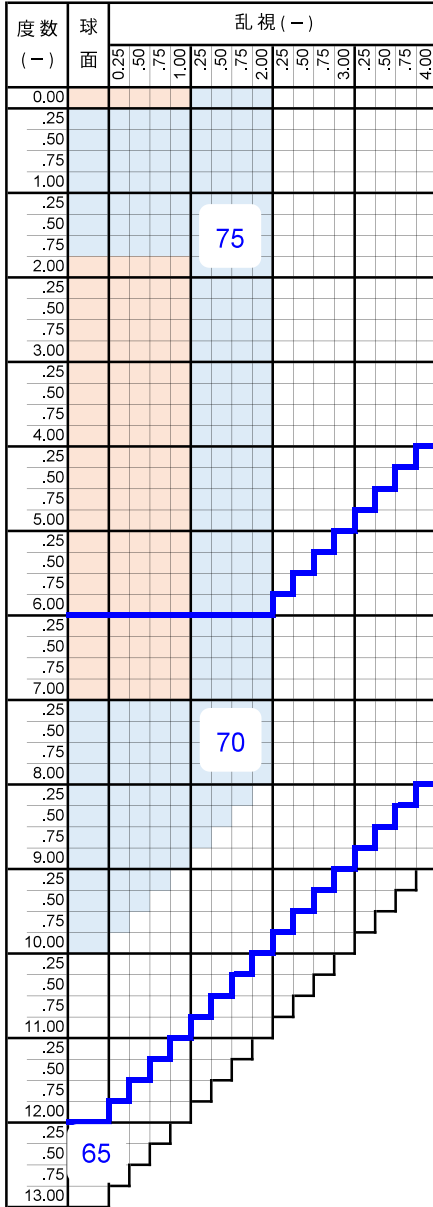

カラー

アリアーテ	○	
レイバン G15・G31・#3	○	
見本色	○	
リラックス	○	※1

特殊加工

外径指定	○	※2
プリズム	○	※3
偏心	×	
カーブ指定	○	
UVカット	標準	※4
厚み指定	○	
玉型カット	○	
スライス加工	○	

※1 プラチナ、プラチナBC、内面マルチは不可

※2 [縮小]
(+, MIX範囲) 基準径~最小55mm (1mm単位)
[拡大]
可表記まで製作可 (1mm単位)

※3 3△まで可

※4 UV400

原産国

在庫品：中国 特注品：日本

仕様

屈折率	1.60
比重	1.30
アッベ数	42
設計	非球面

対応コート

- つるつる
- プラチナ
- プラチナBC
- ブルークリア
- 内面マルチ (表) ハード (裏) ハードマルチ+つるつる

製作範囲表

+ 在庫範囲 (つるつる)
 + 在庫範囲 (プラチナ)

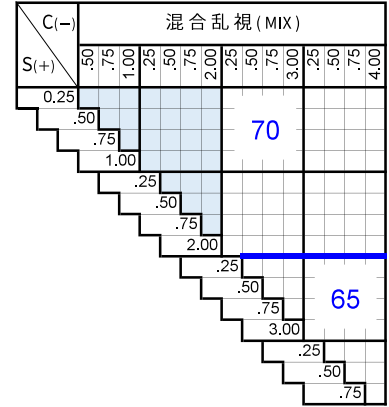
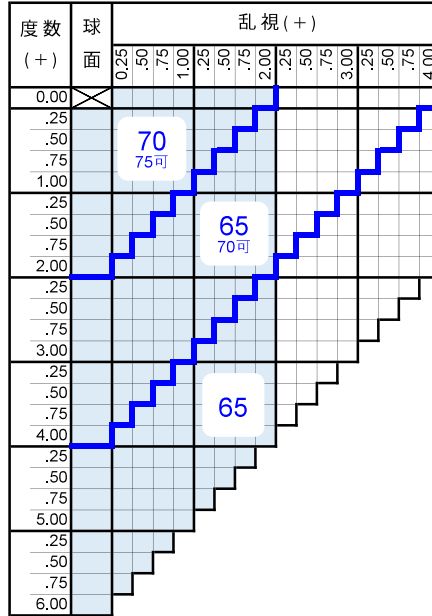
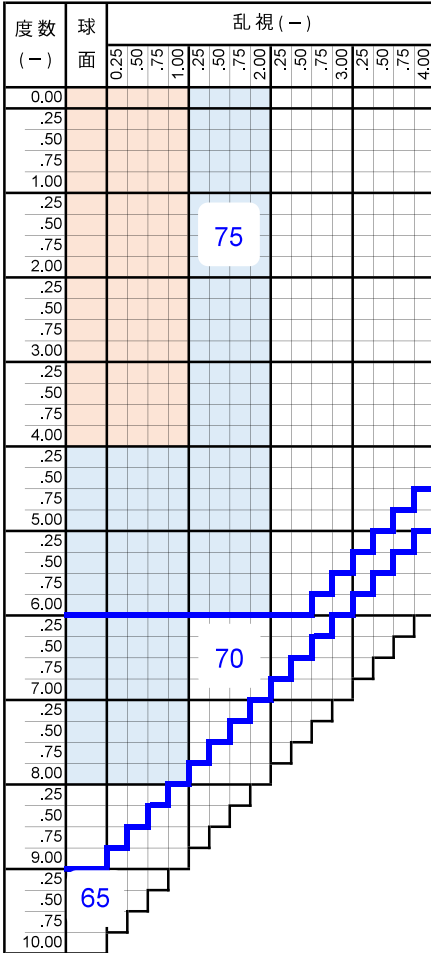

カラー

アリアーテ	○	
レイバン G15・G31・#3	○	
見本色	○	
リラックス	○	※1

特殊加工

外径指定	○	※2
プリズム	○	※3
偏心	×	
カーブ指定	○	
UVカット	標準	※4
厚み指定	○	
玉型カット	○	
スライス加工	○	

※1 プラチナ、プラチナBC、内面マルチは不可

※2 [縮小]
(+, MIX範囲) 基準径~最小55mm (1mm単位)
[拡大]
可表記まで製作可 (1mm単位)

※3 3△まで可

※4 UV400

原産国

在庫品：中国 特注品：日本

仕様

屈折率	1.60
比重	1.30
アッペ数	42
設計	球面

対応コート

- つるつる
- プラチナ
- プラチナBC
- ブルークリア
- 内面マルチ (表) ハード (裏) ハードマルチ+つるつる

製作範囲表

在庫範囲 (つるつる)

度数 (-)	球面	乱視 (-)											
		0.25	.50	.75	1.00	.25	.50	.75	2.00	.25	.50	.75	4.00
0.00													
.25													
.50													
.75													
1.00													
.25													
.50													
.75													
2.00													
.25													
.50													
.75													
3.00													
.25													
.50													
.75													
4.00													
.25													
.50													
.75													
5.00													
.25													
.50													
.75													
6.00													
.25													
.50													
.75													
7.00													
.25													
.50													
.75													
8.00													
.25													
.50													
.75													
9.00													
.25													
.50													
.75													
10.00													

度数 (+)	球面	乱視 (+)											
		0.25	.50	.75	1.00	.25	.50	.75	2.00	.25	.50	.75	4.00
0.00													
.25													
.50													
.75													
1.00													
.25													
.50													
.75													
2.00													
.25													
.50													
.75													
3.00													
.25													
.50													
.75													
4.00													
.25													
.50													
.75													
5.00													
.25													
.50													
.75													
6.00													

C(-)	S(+)	混合乱視 (MIX)														
		.50	.75	1.00	.25	.50	.75	2.00	.25	.50	.75	3.00	.25	.50	.75	4.00
0.25																
.50																
.75																
1.00																
.25																
.50																
.75																
2.00																
.25																
.50																
.75																
3.00																
.25																
.50																
.75																
4.00																

カラー

アリアーテ	○	
レイバン G15・G31・#3	○	
見本色	○	
リラックス	○	※1

特殊加工

外径指定	○	※2
プリズム	○	※3
偏中心	○	※4
カーブ指定	×	
UVカット	標準	※5
厚み指定	○	
玉型カット	○	
スライス加工	○	

※1 つるつるコート、ブルークリアコートのみ ※5 UV400

※2 [縮小]
(+, MIX範囲) 基準径~最小55mm (1mm単位)
[拡大]
可表記まで製作可 (1mm単位)

※3 3△まで可

※4 (プリズム換算) 3△まで可

原産国

在庫品：中国 特注品：日本

SVスーパー74WAS

SV Super74 WAS

プラスチック

単焦点

両面非球面

1.74

仕様

屈折率	1.74
比重	1.47
アッペ数	33
設計	両面非球面

対応コート

- つるつる
- プラチナ
- ブルークリア
- ボードン
- ビューティフル

つるつるコート販売終了
 【販売終了】 2022年5月31日
 【片玉対応】 2022年9月30日

製作範囲表

度数 (-)	球 面	乱視 (-)															
		0.25	.50	.75	1.00	.25	.50	.75	2.00	.25	.50	.75	3.00	.25	.50	.75	4.00
0.00																	
.25																	
.50																	
.75																	
1.00																	
.25																	
.50																	
.75																	
2.00																	
.25																	
.50																	
.75																	
3.00																	
.25																	
.50																	
.75																	
4.00																	
.25																	
.50																	
.75																	
5.00																	
.25																	
.50																	
.75																	
6.00																	
.25																	
.50																	
.75																	
7.00																	
.25																	
.50																	
.75																	
8.00																	
.25																	
.50																	
.75																	
9.00																	
.25																	
.50																	
.75																	
10.00																	
.25																	
.50																	
.75																	
11.00																	
.25																	
.50																	
.75																	
12.00																	
.25																	
.50																	
.75																	
13.00																	
.25																	
.50																	
.75																	
14.00																	
.25																	
.50																	
.75																	
15.00																	

カラー

アリアーテ	○	
レイバン G15・G31・#3	×	
見本色	×	
リラックス	○	

特殊加工

外径指定	×	
プリズム	○	※1
偏心	×	
カーブ指定	×	
UVカット	標準	※2
厚み指定	×	
玉型カット	○	
スライス加工	×	

※1 3△まで可

※2 UV400

原産国

日本

SVスーパー74AS

SV Super74 AS

プラスチック

単焦点

非球面

1.74

仕様

屈折率	1.74
比重	1.47
アッペ数	33
設計	非球面

対応コート

- つるつる
- プラチナ
- ブルークリア
- ボードン
- ビューティフル

つるつるコート販売終了
 【販売終了】 2022年5月31日
 【片玉対応】 2022年9月30日

製作範囲表

度数 (-)	球 面	乱視 (-)															
		0.25	.50	.75	1.00	.25	.50	.75	2.00	.25	.50	.75	3.00	.25	.50	.75	4.00
0.00																	
.25																	
.50																	
.75																	
1.00																	
.25																	
.50																	
.75																	
2.00																	
.25																	
.50																	
.75																	
3.00																	
.25																	
.50																	
.75																	
4.00																	
.25																	
.50																	
.75																	
5.00																	
.25																	
.50																	
.75																	
6.00																	
.25																	
.50																	
.75																	
7.00																	
.25																	
.50																	
.75																	
8.00																	
.25																	
.50																	
.75																	
9.00																	
.25																	
.50																	
.75																	
10.00																	
.25																	
.50																	
.75																	
11.00																	
.25																	
.50																	
.75																	
12.00																	
.25																	
.50																	
.75																	
13.00																	
.25																	
.50																	
.75																	
14.00																	
.25																	
.50																	
.75																	
15.00																	
.25																	
.50																	
.75																	
16.00																	
.25																	
.50																	
.75																	
17.00																	
.25																	
.50																	
.75																	
18.00																	

75

70

65

カラー

アリアーテ	○	
レイバン G15・G31・#3	×	
見本色	×	
リラックス	○	

特殊加工

外径指定	×	
プリズム	○	※1
偏心	×	
カーブ指定	×	
UVカット	標準	※2
厚み指定	×	
玉型カット	○	
スライス加工	×	

※1 3△まで可

※2 UV400

原産国

日本

SVスーパー70WAS

SV Super70 WAS

プラスチック

単焦点

両面非球面

1.70

仕様

屈折率	1.70
比重	1.41
アッペ数	36
設計	両面非球面

対応コート

- つるつる
- プラチナ
- 内面マルチ（表）ハード（裏）ハードマルチ+つるつる

【販売終了】2021年12月31日
【片玉対応】2022年3月31日

代替商品
プレジャーS Vシリーズ

製作範囲表

在庫範囲（つるつる）

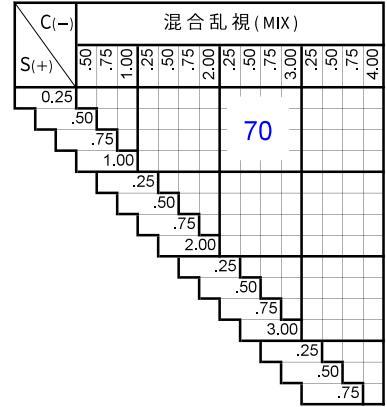
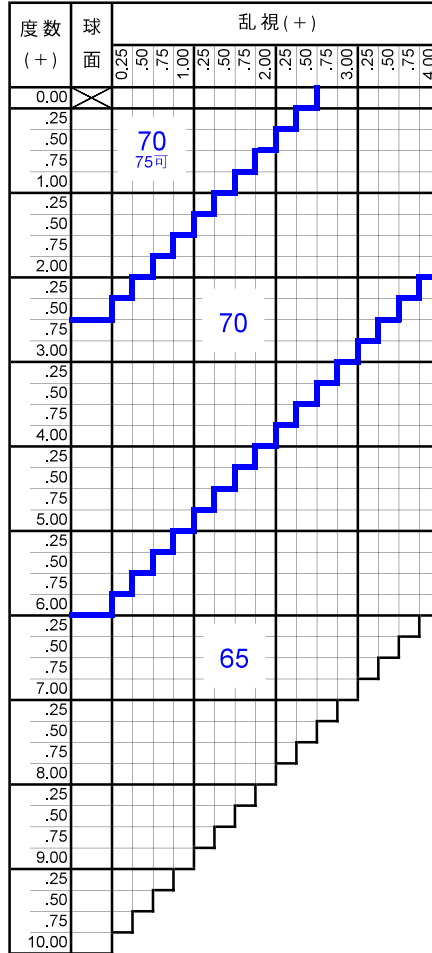
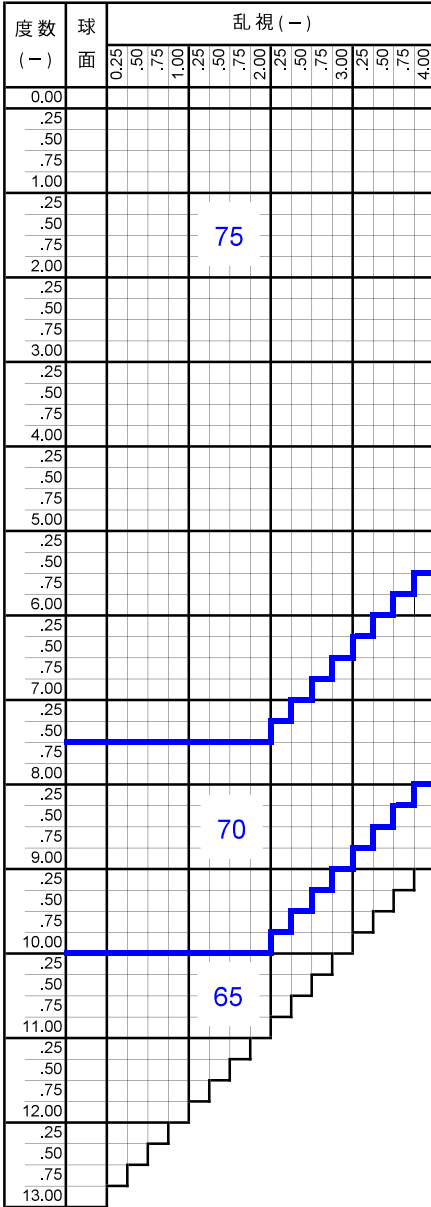

カラー

アリアーテ	○	
レイバン G15・G31・#3	×	
見本色	×	
リラックス	○	※1

原産国

日本

特殊加工

外径指定	○	※2
プリズム	○	※3
偏心	×	
カーブ指定	×	
UVカット	標準	※4
厚み指定	○	
玉型カット	○	
スライス加工	○	

※1 内面マルチは不可

※2 [縮小]
(+、MIX範囲) 基準径~最小55mm (1mm単位)
[拡大]
可表記まで製作可 (1mm単位)

※3 3△まで可

※4 UV400

SVスーパー70AS

SV Super70 AS

プラスチック

単焦点

非球面

1.70

仕様

屈折率	1.70
比重	1.41
アッペ数	36
設計	非球面

対応コート

- つるつる
- プラチナ
- 内面マルチ (表) ハード (裏) ハードマルチ+つるつる

【販売終了】2021年12月31日
【片玉対応】2022年3月31日

代替商品
プレジャーS Vシリーズ

製作範囲表

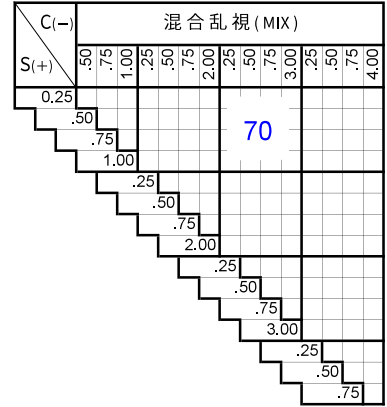
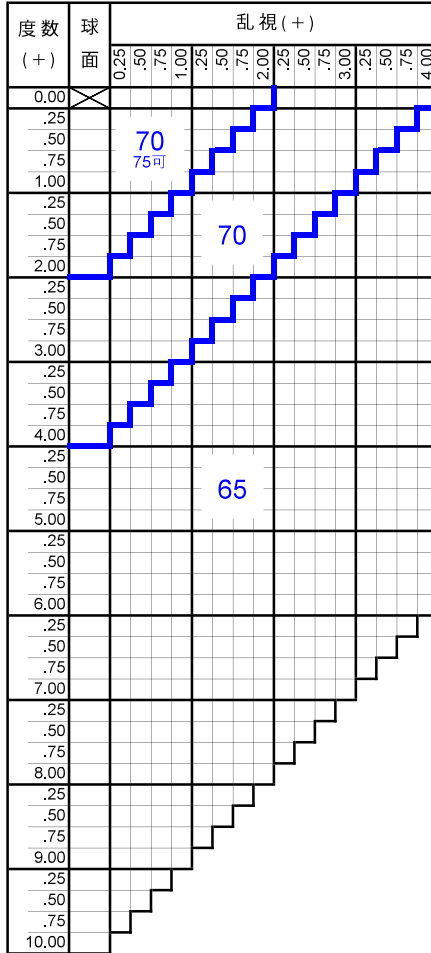
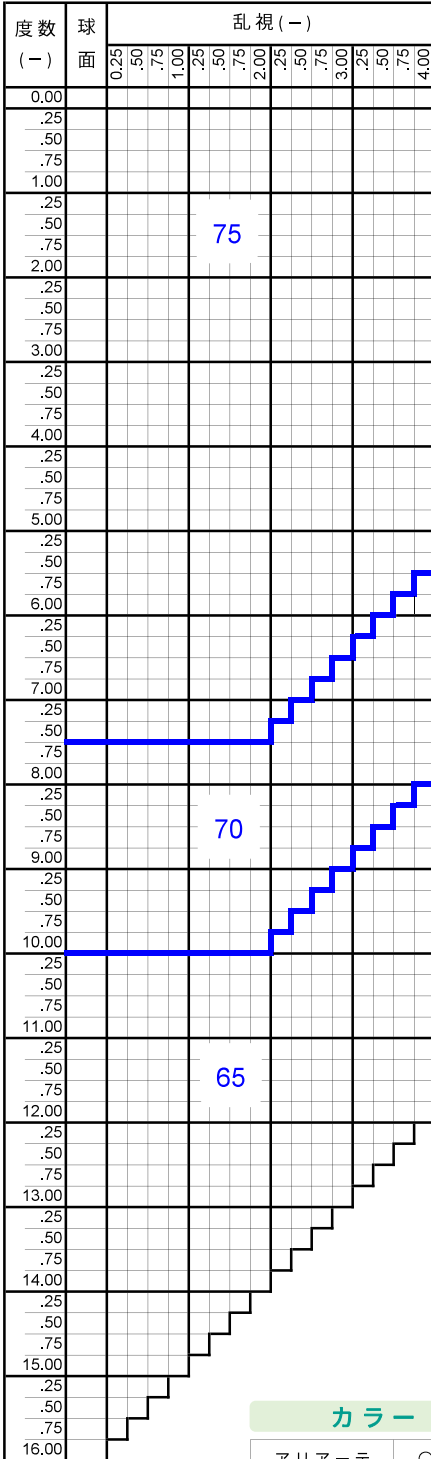

カラー

アリアーテ	○	
レイバン G15・G31・#3	×	
見本色	×	
リラックス	○	※1

特殊加工

外径指定	○	※2
プリズム	○	※3
偏心	×	
カーブ指定	×	
UVカット	標準	※4
厚み指定	○	
玉型カット	○	
スライス加工	○	

※1 内面マルチは不可

※2 [縮小]
(+, MIX範囲) 基準径~最小55mm (1mm単位)
[拡大]
可表記まで製作可 (1mm単位)

※3 3△まで可

※4 UV400

原産国

日本

仕様

屈折率	1.67
比重	1.35
アッペ数	32
設計	非球面

対応コート

- プラチナ
- ブルークリア
- ボードン
- ビューティフル
- 内面マルチ(表)ハード (裏)ハードマルチ+つるつる
- ミラー(シルバー・ゴールド・ブルー・レッド)

製作範囲表

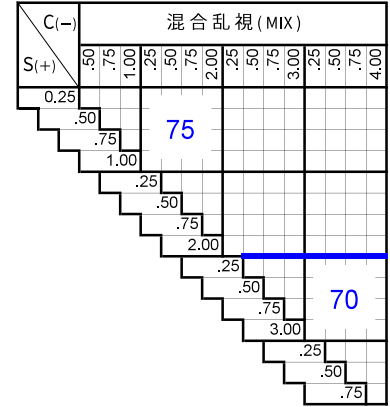
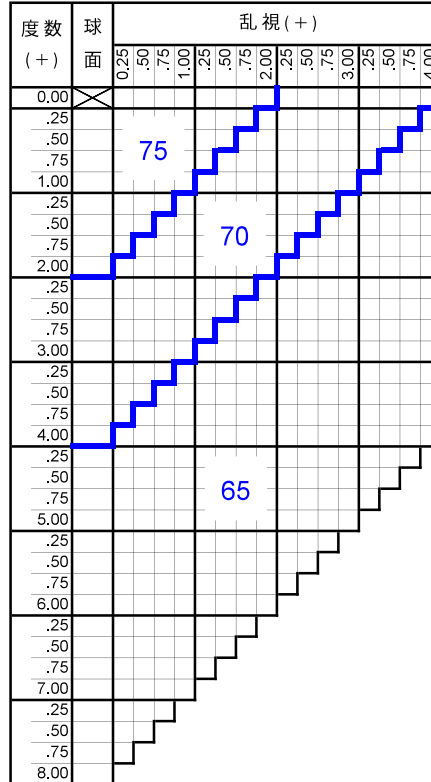
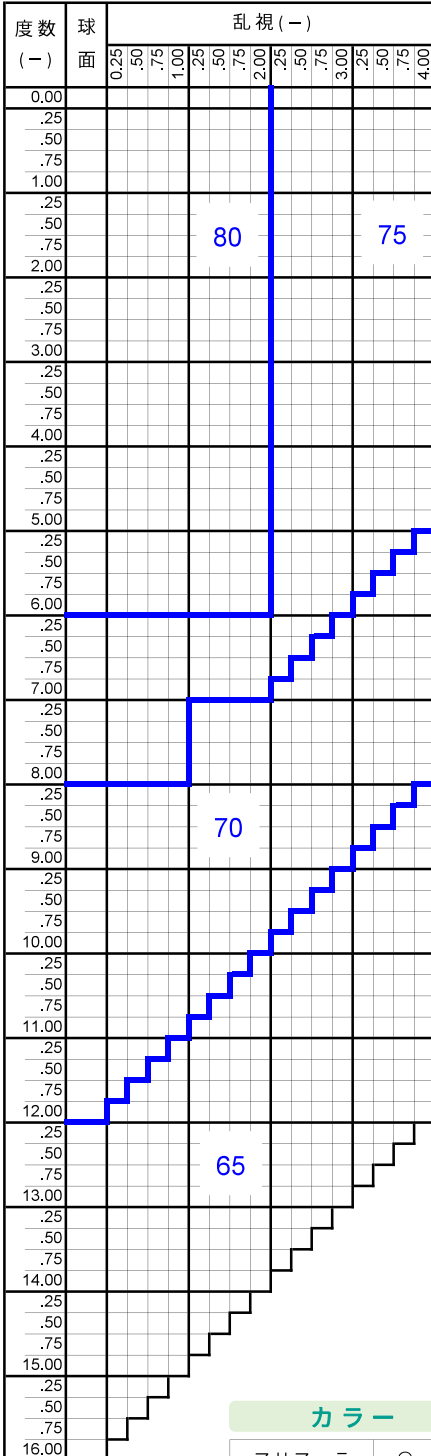

カラー

アリアーテ	○	
レイバン G15・G31・#3	○	
見本色	○	
リラックス	○	※1

特殊加工

外径指定	○	※2
プリズム	○	※3
偏心	×	
カーブ指定	×	
UVカット	標準	※4
厚み指定	○	
玉型カット	○	
スライス加工	○	

※1 内面マルチ、ミラーは不可

※2 [縮小]
(+, MIX範囲) 基準径~最小55mm (1mm単位)

※3 5△まで可

※4 UV400

原産国

在庫品：中国 特注品：日本

仕様

屈折率	1.60
比重	1.31
アッベ数	42
設計	非球面

対応コート

- プラチナ
- ブルークリア
- ボードン
- ビューティフル
- 内面マルチ (表) ハード (裏) ハードマルチ+つるつる
- ミラー (シルバー・ゴールド・ブルー・レッド)

製作範囲表

度数 (-)	球面	乱視 (-)															
		0.25	.50	.75	1.00	.25	.50	.75	2.00	.25	.50	.75	3.00	.25	.50	.75	4.00
0.00																	
.25																	
.50																	
.75																	
1.00																	
.25																	
.50																	
.75																	
2.00																	
.25																	
.50																	
.75																	
3.00																	
.25																	
.50																	
.75																	
4.00																	
.25																	
.50																	
.75																	
5.00																	
.25																	
.50																	
.75																	
6.00																	
.25																	
.50																	
.75																	
7.00																	
.25																	
.50																	
.75																	
8.00																	
.25																	
.50																	
.75																	
9.00																	
.25																	
.50																	
.75																	
10.00																	

度数 (+)	球面	乱視 (+)															
		0.25	.50	.75	1.00	.25	.50	.75	2.00	.25	.50	.75	3.00	.25	.50	.75	4.00
0.00																	
.25																	
.50																	
.75																	
1.00																	
.25																	
.50																	
.75																	
2.00																	
.25																	
.50																	
.75																	
3.00																	
.25																	
.50																	
.75																	
4.00																	
.25																	
.50																	
.75																	
5.00																	
.25																	
.50																	
.75																	
6.00																	

C(-) S(+)	混合乱視 (MIX)																
	.50	.75	1.00	.25	.50	.75	2.00	.25	.50	.75	3.00	.25	.50	.75	4.00		
0.25																	
.50																	
.75																	
1.00																	
.25																	
.50																	
.75																	
2.00																	
.25																	
.50																	
.75																	
3.00																	
.25																	
.50																	
.75																	
4.00																	
.25																	
.50																	
.75																	
5.00																	
.25																	
.50																	
.75																	
6.00																	

カラー

アリアーテ	○	
レイバン G15・G31・#3	○	
見本色	○	※1
リラックス	○	※2

原産国

日本

特殊加工

外径指定	○	※3
プリズム	○	※4
偏心	×	
カーブ指定	×	
UVカット	標準	※5
厚み指定	○	
玉型カット	○	
スライス加工	○	

※1 プラチナ・ブルークリア・ボードンは不可

※2 プラチナ・内面マルチ・ミラーは不可

※3 [縮小]
(+, MIX範囲) 基準径~最小55mm (1mm単位)

※4 3△まで可

※5 UV400

仕様

屈折率	1.60
比重	1.31
アッペ数	42
設計	球面

対応コート

- プラチナ
- ブルークリア
- ボードン
- ビューティフル
- 内面マルチ (表) ハード (裏) ハードマルチ+つるつる
- ミラー (シルバー・ゴールド・ブルー・レッド)

製作範囲表

度数 (-)	球面	乱視 (-)															
		0.25	.50	.75	1.00	.25	.50	.75	2.00	.25	.50	.75	3.00	.25	.50	.75	4.00
0.00																	
.25																	
.50																	
.75																	
1.00																	
.25																	
.50																	
.75																	
2.00																	
.25																	
.50																	
.75																	
3.00																	
.25																	
.50																	
.75																	
4.00																	
.25																	
.50																	
.75																	
5.00																	
.25																	
.50																	
.75																	
6.00																	
.25																	
.50																	
.75																	
7.00																	
.25																	
.50																	
.75																	
8.00																	
.25																	
.50																	
.75																	
9.00																	
.25																	
.50																	
.75																	
10.00																	

度数 (+)	球面	乱視 (+)															
		0.25	.50	.75	1.00	.25	.50	.75	2.00	.25	.50	.75	3.00	.25	.50	.75	4.00
0.00																	
.25																	
.50																	
.75																	
1.00																	
.25																	
.50																	
.75																	
2.00																	
.25																	
.50																	
.75																	
3.00																	
.25																	
.50																	
.75																	
4.00																	
.25																	
.50																	
.75																	
5.00																	
.25																	
.50																	
.75																	
6.00																	

C(-) S(+)	混合乱視 (MIX)																
	.50	.75	1.00	.25	.50	.75	2.00	.25	.50	.75	3.00	.25	.50	.75	4.00		
0.25																	
.50																	
.75																	
1.00																	
.25																	
.50																	
.75																	
2.00																	
.25																	
.50																	
.75																	
3.00																	
.25																	
.50																	
.75																	
4.00																	
.25																	
.50																	
.75																	
5.00																	
.25																	
.50																	
.75																	
6.00																	

カラー

アリアーテ	○	
レイバン G15・G31・#3	○	
見本色	○	※1
リラックス	○	※2

特殊加工

外径指定	○	※3
プリズム	○	※4
偏心	○	
カーブ指定	×	
UVカット	標準	※5
厚み指定	○	
玉型カット	○	
スライス加工	○	

※1 プラチナ・ブルークリア・ボードンは不可

※2 内面マルチ、ミラーは不可

※3 [縮小]
(+, MIX範囲) 基準径~最小55mm (1mm単位)

※4 3△まで可

※5 UV400

原産国

日本

仕様

屈折率	1.50
比重	1.32
アッペ数	59
設計	球面

対応コート

- ハード
- ハードマルチ
- つるつる
- 内面マルチ (表) ハード (裏) ハードマルチ+つるつる
- ミラー (シルバー・ゴールド・ブルー・レッド)

製作範囲表

度数 (-)	球面	乱視 (-)								
		0.25	.50	.75	1.00	.25	.50	.75	2.00	
0.00										
.25										
.50										
.75										
1.00										
.25										
.50										
.75										
2.00										
.25										
.50										
.75										
3.00										
.25										
.50										
.75										
4.00										
.25										
.50										
.75										
5.00										
.25										
.50										
.75										
6.00										

度数 (+)	球面	乱視 (+)								
		0.25	.50	.75	1.00	.25	.50	.75	2.00	
0.00										
.25										
.50										
.75										
1.00										
.25										
.50										
.75										
2.00										
.25										
.50										
.75										
3.00										
.25										
.50										
.75										
4.00										
.25										
.50										
.75										
5.00										
.25										
.50										
.75										
6.00										

C(-)	混合乱視 (MIX)						
	.50	.75	1.00	.25	.50	.75	2.00
S(+)							
0.25							
.50							
.75							
1.00							
.25							
.50							
.75							

カラー

アリアーテ	○	
レイバン G15・G31・#3	○	
見本色	○	
リラックス	×	

特殊加工

外径指定	×	
プリズム	×	
偏心	×	
カーブ指定	×	
UVカット	○	※1
厚み指定	×	
玉型カット	○	
スライス加工	×	

※1 UV400

原産国

在庫品：中国 特注品：日本

PLI.55 AS

PLI.55 AS

プラスチック

単焦点

非球面

1.55

仕様

屈折率	1.55
比重	1.28
アッペ数	38
設計	非球面

対応コート

- ハードマルチ
- つるつる
- 内面マルチ (表) ハード (裏) ハードマルチ+つるつる

製作範囲表

在庫範囲 (つるつる)

度数 (-)	球面	乱視 (-)				
		0.25	.50	.75	1.00	2.00
0.00						
.25						
.50						
.75						
1.00						
.25						
.50						
.75						
2.00						
.25						
.50						
.75						
3.00						
.25						
.50						
.75						
4.00						
.25						
.50						
.75						
5.00						
.25						
.50						
.75						
6.00						
.25						
.50						
.75						
7.00						
.25						
.50						
.75						
8.00						

度数 (+)	球面	乱視 (+)				
		0.25	.50	.75	1.00	2.00
0.00						
.25						
.50						
.75						
1.00						
.25						
.50						
.75						
2.00						
.25						
.50						
.75						
3.00						
.25						
.50						
.75						
4.00						

C(-)	混合乱視 (MIX)				
	.50	1.00	.25	.75	2.00
S(+)					
0.25					
.50					
.75					
1.00					
.25					
.50					
.75					

カラー

アリアーテ	○	
レイバン G15・G31・#3	○	
見本色	○	
リラックス	×	

特殊加工

外径指定	×	
プリズム	×	
偏心	×	
カーブ指定	×	
UVカット	標準	※1
厚み指定	×	
玉型カット	○	
スライス加工	×	

※1 UV400

※注 無色在庫品には、超撥水コート加工時の滑り止めテープが不要な「フィルムコートが、レンズの表面と裏面に付いています。
(特注品にはフィルムコートが付きませんのでご注意ください。)

- ・ハードマルチと同様の手順で加工できます
- ・フィルムコートは加工後、水洗いで剥がれ落ちます。
- ・フィルムコートはセロハンテープ等で簡単に剥がせます。

印点がずれてしまった場合や (アルコール等で拭かないでください。フィルムが溶ける場合があります) サクションカップの取り付け違いがあった場合などは、セロハンテープ等でフィルムを剥がし、通常の超撥水コートと同様の手順で加工してください。

原産国

在庫品：中国 特注品：日本

仕様

屈折率	1.55
比重	1.28
アッペ数	38
設計	球面

対応コート

- ハードマルチ
- 内面マルチ (表) ハード (裏) ハードマルチ+つるつる

製作範囲表

在庫範囲 (ハードマルチ)

度数 (-)	球面	乱視 (-)					
		0.25	.50	.75	1.00	.25	.50
0.00							
.25							
.50							
.75							
1.00							
.25							
.50							
.75							
2.00							
.25							
.50							
.75							
3.00							
.25							
.50							
.75							
4.00							
.25							
.50							
.75							
5.00							
.25							
.50							
.75							
6.00							
.25							
.50							
.75							
7.00							
.25							
.50							
.75							
8.00							

度数 (+)	球面	乱視 (+)					
		0.25	.50	.75	1.00	.25	.50
0.00							
.25							
.50							
.75							
1.00							
.25							
.50							
.75							
2.00							
.25							
.50							
.75							
3.00							
.25							
.50							
.75							
4.00							

C(-)	混合乱視 (MIX)					
	.50	.75	1.00	.25	.50	.75
S(+)						
0.25						
.50						
.75						
1.00						
.25						
.50						
.75						

カラー

アリアーテ	○	
レイバン G15・G31・#3	○	
見本色	○	
リラックス	×	

特殊加工

外径指定	×	
プリズム	×	
偏心	×	
カーブ指定	×	
UVカット	標準	※1
厚み指定	×	
玉型カット	○	
スライス加工	×	

※1 UV400

原産国

在庫品：中国 特注品：日本

ブルーテック67AS RX

Blue Tech 67AS RX

プラスチック

単焦点

非球面

1.67

仕様

屈折率	1.67
比重	1.35
アッペ数	32
設計	非球面

対応コート

- つるつる
- プラチナ
- プラチナDUV
- プラチナBC
- プラチナIRB
- ボードン
- ビューティフル
- 内面マルチ (表) ハード (裏) ハードマルチ+つるつる

製作範囲表

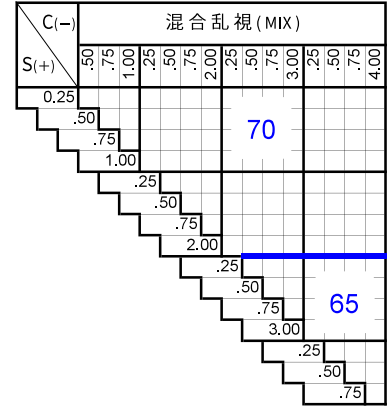
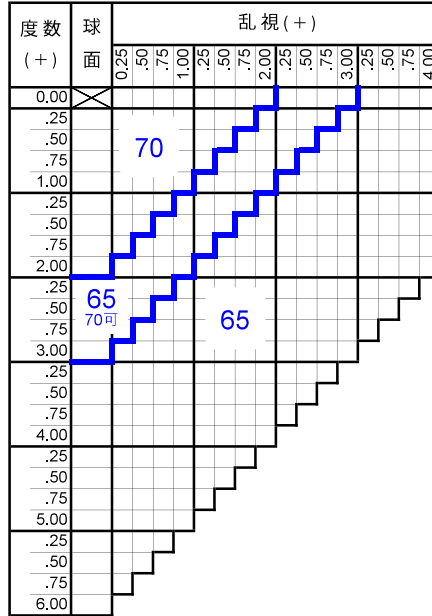
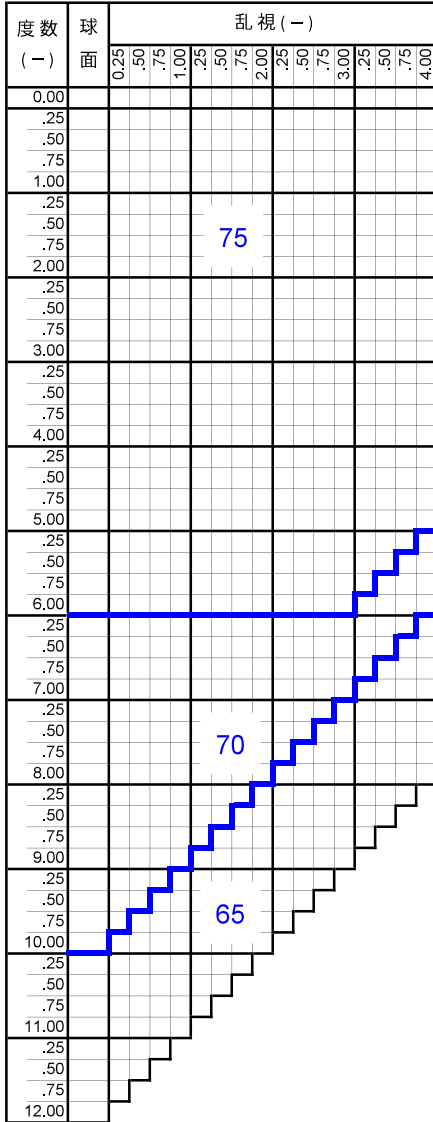

カラー

アリアーテ	○	※1
レイバン G15・G31・#3	×	
見本色	×	
リラックス	×	

原産国

日本・中国

特殊加工

外径指定	○	※2
プリズム	○	※3
偏心	×	
カーブ指定	×	
UVカット	標準	※4
厚み指定	○	
玉型カット	○	
スライス加工	○	

- ※1 対象濃度25%以上
度数により色調が変化します。従来のレンズに比べて照明による色調の変化が起こります。ハーフ染色の場合は基材の色の干渉を受けますのでご注意ください。
アリアーテ見本に比べ、くすみが多くなります。
- ※2 [縮小]
(+, MIX範囲) 基準径~最小55mm (1mm単位)
[拡大]
可表記まで製作可 (1mm単位)
- ※3 3△まで可
(-) S+C=-10.00まで
(+) (MIX) 全範囲
- ※4 UV420

ブルーテック67AS

Blue Tech 67AS

プラスチック

単焦点

非球面

1.67

仕様

屈折率	1.67
比重	1.35
アッペ数	32
設計	非球面

対応コート

- つるつる
 - プラチナ
 - プラチナDUV
 - プラチナBC
 - プラチナIRB
 - ボードン
 - ビューティフル
- 内面マルチ（表）ハード（裏）ハードマルチ+つるつる

製作範囲表

在庫範囲（つるつる）

度数 (-)	球面	乱視(-)												
		0.25	.50	.75	1.00	1.25	1.50	1.75	2.00	2.25	2.50	2.75	3.00	
0.00														
.25														
.50														
.75														
1.00														
.25														
.50														
.75														
2.00														
.25														
.50														
.75														
3.00														
.25														
.50														
.75														
4.00														
.25														
.50														
.75														
5.00														
.25														
.50														
.75														
6.00														
.25														
.50														
.75														
7.00														
.25														
.50														
.75														
8.00														
.25														
.50														
.75														
9.00														
.25														
.50														
.75														
10.00														

カラー

アリアーテ	○	※1
レイバン G15・G31・#3	×	
見本色	×	
リラックス	×	

原産国

日本・中国

特殊加工

外径指定	×	
プリズム	×	
偏心	×	
カーブ指定	×	
UVカット	標準	※2
厚み指定	×	
玉型カット	○	
スライス加工	×	

※1 対象濃度25%以上
度数により色調が変化します。従来のレンズに比べて照明による色調の変化が起こります。
ハーフ染色の場合は基材の色の干渉を受けますのでご注意ください。
アリアーテ見本に比べ、くすみが多くなります。

※2 UV420

※注 特注加工はRXにてご注文をお願い致します。
商品名：ブルーテック67ASRX
(在庫範囲カラーは除く)

ブルーテック60AS RX

Blue Tech 60AS RX

プラスチック

単焦点

非球面

1.60

仕様

屈折率	1.60
比重	1.24
アッペ数	42
設計	非球面

対応コート

- つるつる
- プラチナ
- プラチナDUV
- プラチナBC
- プラチナIRB
- ボードン
- ビューティフル
- 内面マルチ (表) ハード (裏) ハードマルチ+つるつる

製作範囲表

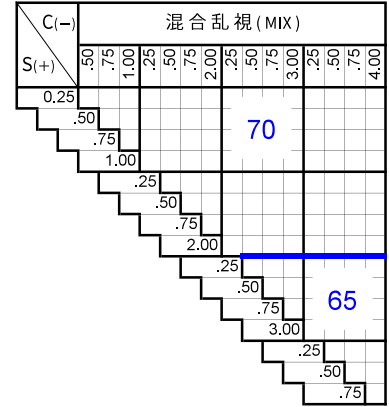
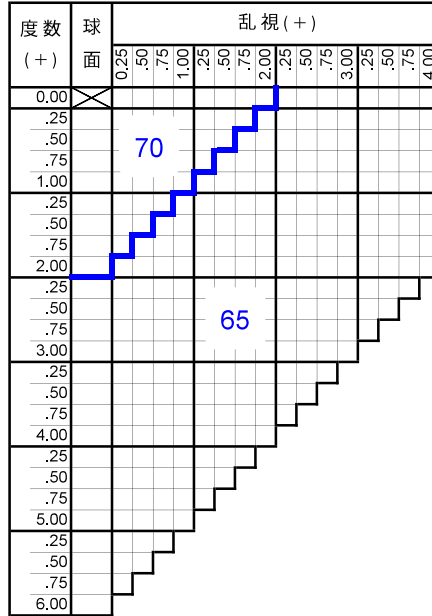
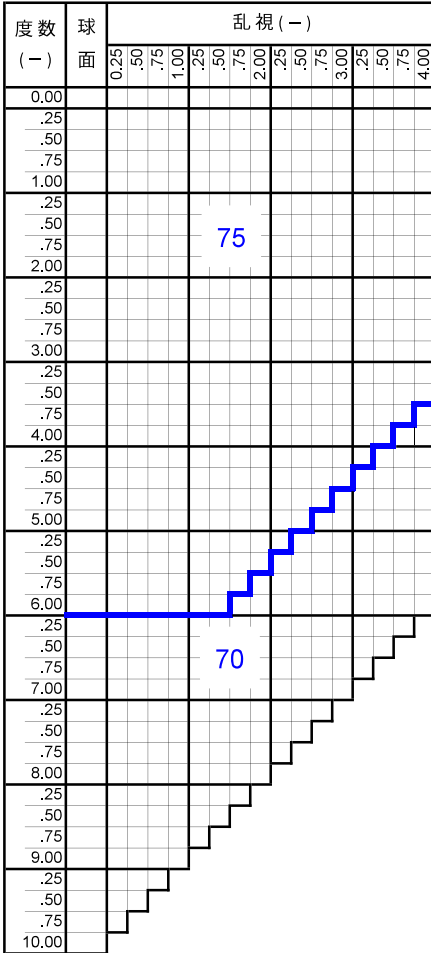

カラー

アリアーテ	○	※1
レイバン G15・G31・#3	×	
見本色	×	
リラックス	×	

原産国

日本・中国

特殊加工

外径指定	○	※2
プリズム	○	※3
偏心	×	
カーブ指定	×	
UVカット	標準	※4
厚み指定	○	
玉型カット	○	
スライス加工	○	

※1 対象濃度25%以上
度数により色調が変化します。従来のレンズに比べて照明による色調の変化が起こります。ハーフ染色の場合は基材の色の干渉を受けますのでご注意ください。アリアーテ見本に比べ、くすみが多くなります。

※2 [縮小]
(+, MIX範囲) 基準径~最小55mm (1mm単位)

※3 3△まで可

※4 UV420

ブルーテック60AS

Blue Tech 60AS

プラスチック

単焦点

非球面

1.60

仕様

屈折率	1.60
比重	1.24
アッペ数	42
設計	非球面

対応コート

- つるつる
 - プラチナ
 - プラチナDUV
 - プラチナBC
 - プラチナIRB
 - ボードン
 - ビューティフル
- 内面マルチ (表) ハード (裏) ハードマルチ+つるつる

製作範囲表

+ 在庫範囲 (つるつる) 在庫範囲 (プラチナDUV)

度数 (-)	球面	乱視 (-)							
		0.25	.50	.75	1.00	.25	.50	.75	1.00
0.00									
.25									
.50									
.75									
1.00									
.25									
.50									
.75									
2.00									
.25									
.50									
.75									
3.00									
.25									
.50									
.75									
4.00									
.25									
.50									
.75									
5.00									
.25									
.50									
.75									
6.00									
.25									
.50									
.75									
7.00									
.25									
.50									
.75									
8.00									

度数 (+)	球面	乱視 (+)							
		0.25	.50	.75	1.00	.25	.50	.75	2.00
0.00									
.25									
.50									
.75									
1.00									
.25									
.50									
.75									
2.00									
.25									
.50									
.75									
3.00									
.25									
.50									
.75									
4.00									

C(-)	混合乱視 (MIX)							
	0.25	.50	.75	1.00	.25	.50	.75	2.00
S(+)								
.25								
.50								
.75								
1.00								
.25								
.50								
.75								

カラー

アリアーテ	○	※1
レイバン G15・G31・#3	×	
見本色	×	
リラックス	×	

原産国

日本・中国

特殊加工

外径指定	×	
プリズム	×	
偏心	×	
カーブ指定	×	
UVカット	標準	※2
厚み指定	×	
玉型カット	○	
スライス加工	×	

※1 対象濃度25%以上
度数により色調が変化します。従来のレンズに比べて照明による色調の変化が起こります。
ハーフ染色の場合は基材の色の干渉を受けますのでご注意ください。
アリアーテ見本に比べ、くすみが多くなります。

※2 UV420

※注 特注加工はRXにてご注文をお願い致します。
商品名：ブルーテック60ASRX
(在庫範囲カラーは除く)

ブルーテック55AS

Blue Tech 55AS

プラスチック

単焦点

非球面

1.55

仕様

屈折率	1.55
比重	1.28
アッペ数	38
設計	非球面

対応コート

●つるつる

製作範囲表

在庫範囲 (つるつる)

度数 (-)	球面	乱視(-)				
		0.25	.50	.75	1.00	2.00
0.00						
.25						
.50						
.75						
1.00						
.25						
.50						
.75						
2.00						
.25						
.50						
.75						
3.00						
.25						
.50						
.75						
4.00						
.25						
.50						
.75						
5.00						
.25						
.50						
.75						
6.00						
.25						
.50						
.75						
7.00						
.25						
.50						
.75						
8.00						

度数 (+)	球面	乱視(+)				
		0.25	.50	.75	1.00	2.00
0.00						
.25						
.50						
.75						
1.00						
.25						
.50						
.75						
2.00						
.25						
.50						
.75						
3.00						
.25						
.50						
.75						
4.00						

C(-)	混合乱視 (MIX)				
	.50	.75	1.00	.25	.75
S(+)					
0.25					
.50					
.75					
1.00					
.25					
.50					
.75					

カラー

アリアーテ	×	
レイバン G15・G31・#3	×	
見本色	×	
リラックス	×	

特殊加工

外径指定	×	
プリズム	×	
偏心	×	
カーブ指定	×	
UVカット	標準	※1
厚み指定	×	
玉型カット	○	
スライス加工	×	

※1 UV420

※注 常備在庫レンズのみの設定となります。
カラー、外径指定等の特注加工はお受けできませんのでご注意ください。

原産国

中国

仕様

屈折率	1.56
比重	1.25
アッペ数	44
設計	非球面

対応コート

●つるつる

製作範囲表

在庫範囲 (つるつる)

度数 (-)	球面	乱視(-)							
		0.25	.50	.75	1.00	.25	.50	.75	2.00
0.00									
.25									
.50									
.75									
1.00									
.25									
.50									
.75									
2.00									
.25									
.50									
.75									
3.00									
.25									
.50									
.75									
4.00									
.25									
.50									
.75									
5.00									
.25									
.50									
.75									
6.00									

度数 (+)	球面	乱視(+)							
		0.25	.50	.75	1.00	.25	.50	.75	2.00
0.00									
.25									
.50									
.75									
1.00									
.25									
.50									
.75									
2.00									
.25									
.50									
.75									
3.00									
.25									
.50									
.75									
4.00									

C(-)	混合乱視 (MIX)						
	.50	.75	1.00	.25	.50	.75	2.00
S(+)							
.25							
.50							
.75							
1.00							
.25							
.50							
.75							

カラー

アリアーテ	○	
レイバン G15・G31・#3	○	
見本色	○	
リラックス	×	

特殊加工

外径指定	×	
プリズム	×	
偏心	×	
カーブ指定	×	
UVカット	標準	※1
厚み指定	×	
玉型カット	○	
スライス加工	×	

※1 UV400

原産国

日本・中国

匠のプリズム60

Takumi Prism 60

プラスチック

単焦点

球面

1.60

仕様

屈折率	1.60
比重	1.30
アッペ数	42
設計	球面

対応コート

- つるつる
- プラチナ
- ブルークリア
- ビューティフル

製作範囲表

度数 (-)	球面	乱視(-)															
		0.25	.50	.75	1.00	.25	.50	.75	2.00	.25	.50	.75	3.00	.25	.50	.75	4.00
0.00																	
.25																	
.50																	
.75																	
1.00																	
.25																	
.50																	
.75																	
2.00																	
.25																	
.50																	
.75																	
3.00																	
.25																	
.50																	
.75																	
4.00																	
.25																	
.50																	
.75																	
5.00																	
.25																	
.50																	
.75																	
6.00																	
.25																	
.50																	
.75																	
7.00																	
.25																	
.50																	
.75																	
8.00																	

度数 (+)	球面	乱視(+)															
		0.25	.50	.75	1.00	.25	.50	.75	2.00	.25	.50	.75	3.00	.25	.50	.75	4.00
0.00																	
.25																	
.50																	
.75																	
1.00																	
.25																	
.50																	
.75																	
2.00																	
.25																	
.50																	
.75																	
3.00																	
.25																	
.50																	
.75																	
4.00																	

C(-) S(+)	混合乱視(MIX)																
	.50	.75	1.00	.25	.50	.75	2.00	.25	.50	.75	3.00	.25	.50	.75	4.00		
0.25																	
.50																	
.75																	
1.00																	
.25																	
.50																	
.75																	
2.00																	
.25																	
.50																	
.75																	
3.00																	
.25																	
.50																	
.75																	
4.00																	

カラー

アリアーテ	○	
レイバン G15・G31・#3	○	
見本色	○	
リラックス	×	

特殊加工

外径指定	○	※1
プリズム	○	※2
偏心	×	
カーブ指定	×	
UVカット	標準	※3
厚み指定	○	
玉型カット	○	※4
スライス加工	○	

※1 縮小
(+、MIX範囲) 基準径~最小55mm (1mm単位)

※2 5△まで可

※3 UV400

※4 無料

※ 度数交換保証3ヶ月あり

原産国

日本

匠のシリンダー60

Takumi Cylinder 60

プラスチック

単焦点

非球面

1.60

仕様

屈折率	1.60
比重	1.30
アッペ数	42
設計	非球面

対応コート

- つるつる
- プラチナ
- ブルークリア
- ビューティフル

製作範囲表

度数 (-)	球面	乱視(-)															
		0.25	.50	.75	1.00	.25	.50	.75	1.00	.25	.50	.75	1.00	.25	.50	.75	1.00
0.00																	
.25																	
.50																	
.75																	
1.00																	
.25																	
.50																	
.75																	
2.00																	
.25																	
.50																	
.75																	
3.00																	
.25																	
.50																	
.75																	
4.00																	
.25																	
.50																	
.75																	
5.00																	
.25																	
.50																	
.75																	
6.00																	

度数 (+)	球面	乱視(+)															
		0.25	.50	.75	1.00	.25	.50	.75	1.00	.25	.50	.75	1.00	.25	.50	.75	1.00
0.00																	
.25																	
.50																	
.75																	
1.00																	
.25																	
.50																	
.75																	
2.00																	
.25																	
.50																	
.75																	
3.00																	
.25																	
.50																	
.75																	
4.00																	
.25																	
.50																	
.75																	
5.00																	
.25																	
.50																	
.75																	
6.00																	

C(-) S(+)	混合乱視(MIX)																		
	.50	.75	1.00	.25	.50	.75	1.00	.25	.50	.75	1.00	.25	.50	.75	1.00	.25	.50	.75	1.00
0.25																			
.50																			
.75																			
1.00																			
.25																			
.50																			
.75																			
2.00																			
.25																			
.50																			
.75																			
3.00																			
.25																			
.50																			
.75																			
4.00																			
.25																			
.50																			
.75																			
5.00																			
.25																			
.50																			
.75																			
6.00																			

カラー

アリアーテ	○	
レイバン G15・G31・#3	○	
見本色	○	
リラックス	×	

特殊加工

外径指定	○	※1
プリズム	×	
偏心	×	
カーブ指定	×	
UVカット	標準	※2
厚み指定	○	
玉型カット	○	※3
スライス加工	○	

- ※1 [縮小]
(+、MIX範囲) 基準径~最小55mm (1mm単位)
- ※2 UV400
- ※3 無料
- ※ 度数交換保証3ヶ月あり

原産国

日本